



Reproduzierbare Charakterisierung von nützlichen und störenden Reflexionen

von bedrucktem Papier zu emittierenden elektro-optischen Anzeigen.

Eine Implementierung der Methode von Sharp-Little aus dem Jahr 1920.

Reproducible characterization of intended and unwanted reflections

from printed paper to emissive electronic displays.

An implementation of the Sharp-Little method from 1920.



Which of those berries you should NOT eat ?



Evolution and optimization of the visual system - over millions of years - as a means of survival in the respective existing environment.

- ◆ **Friend - Foe recognition;**
Fight, flight, submission, neutrality.
- ◆ **Food recognition & classification;**
edibility, ripe / unripe.
- ◆ **Sustainment of species;**
Choice of partner: state of health.
- ◆ **Social aspects;**
Communication, greeting, courtship, moods, hierarchy, dominance, ...

**Critical decisions
must be made
quickly and unerringly**

All characteristics that have contributed to the survival of our ancestors are preserved in our current visual system.



Sensation - Perception

Color - a characteristic of visual perception that can be described by attributes of hue, brightness (or lightness) and colorfulness (or saturation or chroma) stimulated by light (= electro-magnetic radiation in the wavelength range from ~360 nm to ~800 nm).

Color is a visual perception enabling the discrimination of two adjacent otherwise featureless parts of the visual field with one single resting eye.

according to DIN 5033

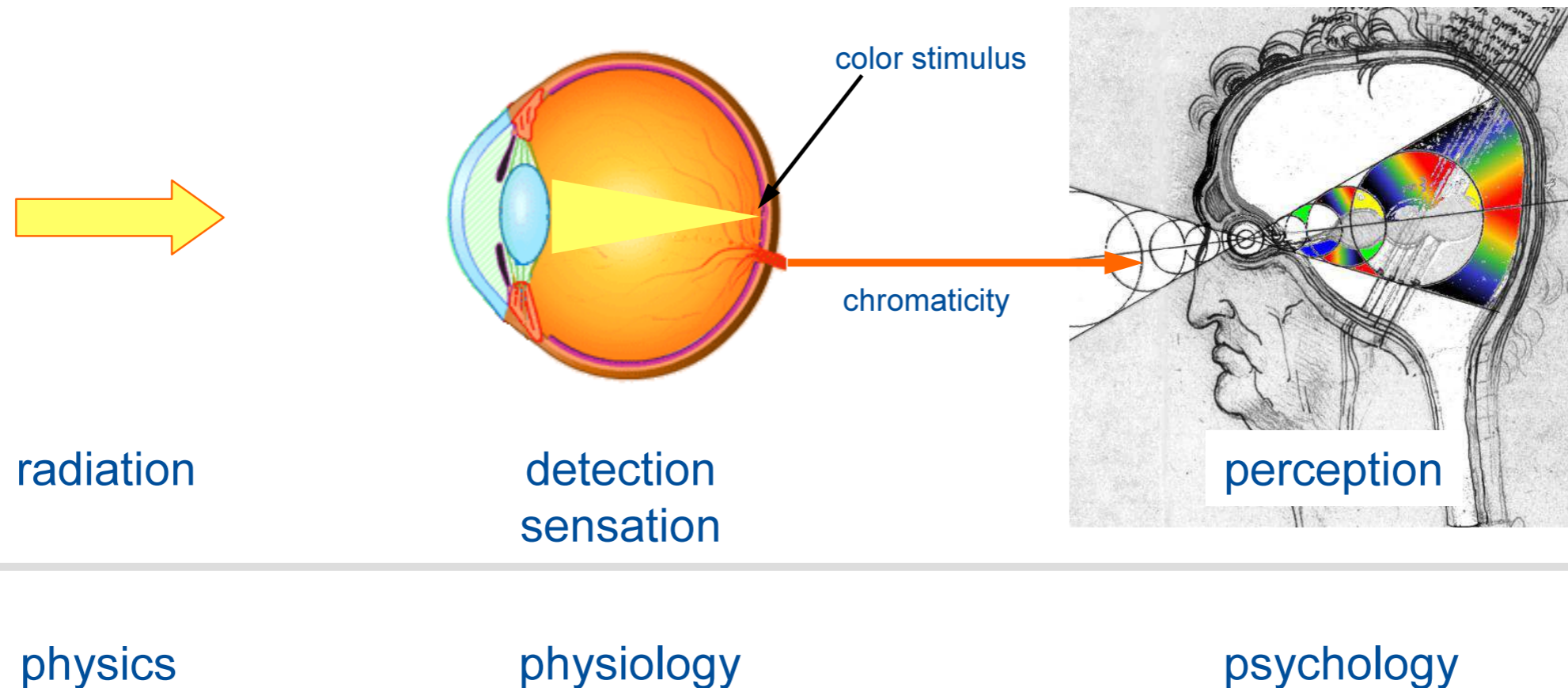

Color – a visual sensation → perception

Sensation: Sensory receptors are specialized neurons that respond to specific types of stimuli. When sensory information is detected by a sensory receptor, sensation has occurred.

Perception: requires organization (classification) and interpretation of incoming sensory information.

- Visual stimulus: **reflected light** in most cases,
coloration caused by selective absorption during the process of reflection: surface/object colors
- **scattered light:** skies, water, milk,
- **emitted light**
 - thermal excitation, e.g. flames: candle, fire, gas flame, ...
 - thermo-nuclear excitation: stars, sun,
 - electrical discharges: e.g. lightning,
 - electro-luminescence (LED, OLED, ...)
 - bio-luminescence: e.g. fireflies, glow-worms.

Monochromatic stimuli are characterized by their wavelength in vacuum, λ_0 .



Identification of subtle clues



matte - scattering - surface

glossy - mirror like - surface



Appearance

"Appearance of an object, the collected visual aspects

Perceived appearance: visual perception including size, shape, color, texture, gloss, transparency / opacity, etc.,"

The **visual appearance of objects** is given by the way in which they reflect and transmit light.

The **color of objects** is determined by the parts of the spectrum of incident white light that are reflected or transmitted without being absorbed.



Additional appearance attributes are based on the **directional distribution** of reflected or transmitted light described by attributes like glossy, shiny versus dull, matte, clear, distinct, etc..

The reflective properties are determined by the **micro-topography** of surfaces (e.g. scales of hair fibers).

Structures on the surface typically range between some 10 mm and 0,1 mm (the detection limit of the human eye is at ~0,07 mm).

Smaller structures and features cannot be seen directly, but their effect becomes apparent in images reflected in the surface:

- ♦ structures at and below 0,1mm **reduce the distinctness of image (DOI)**,
- ♦ structures in the range of 0,01 mm **induce haze** and even
- ♦ smaller structures (< 10 μm) **reduce the gloss** of the surface.



Attributes of appearance



COLOUR

Modification of spectral distribution

GLOSS

Specular reflection at the front of the object



SPARKLE

Texture dependent on direction

APPEARANCE

FLU
spe



SURFACE TEXTURE

Spatial variation in reflection or transmission

TRANSLUCENCY

Transmission through the object



Path Tracing
30 hours



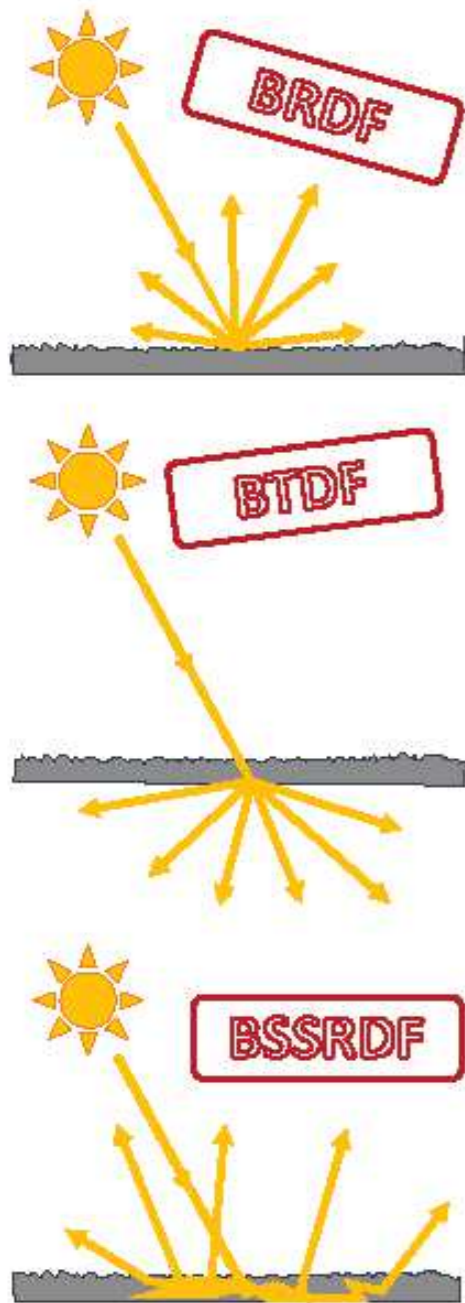

BRDF – BTDF - BSSRDF

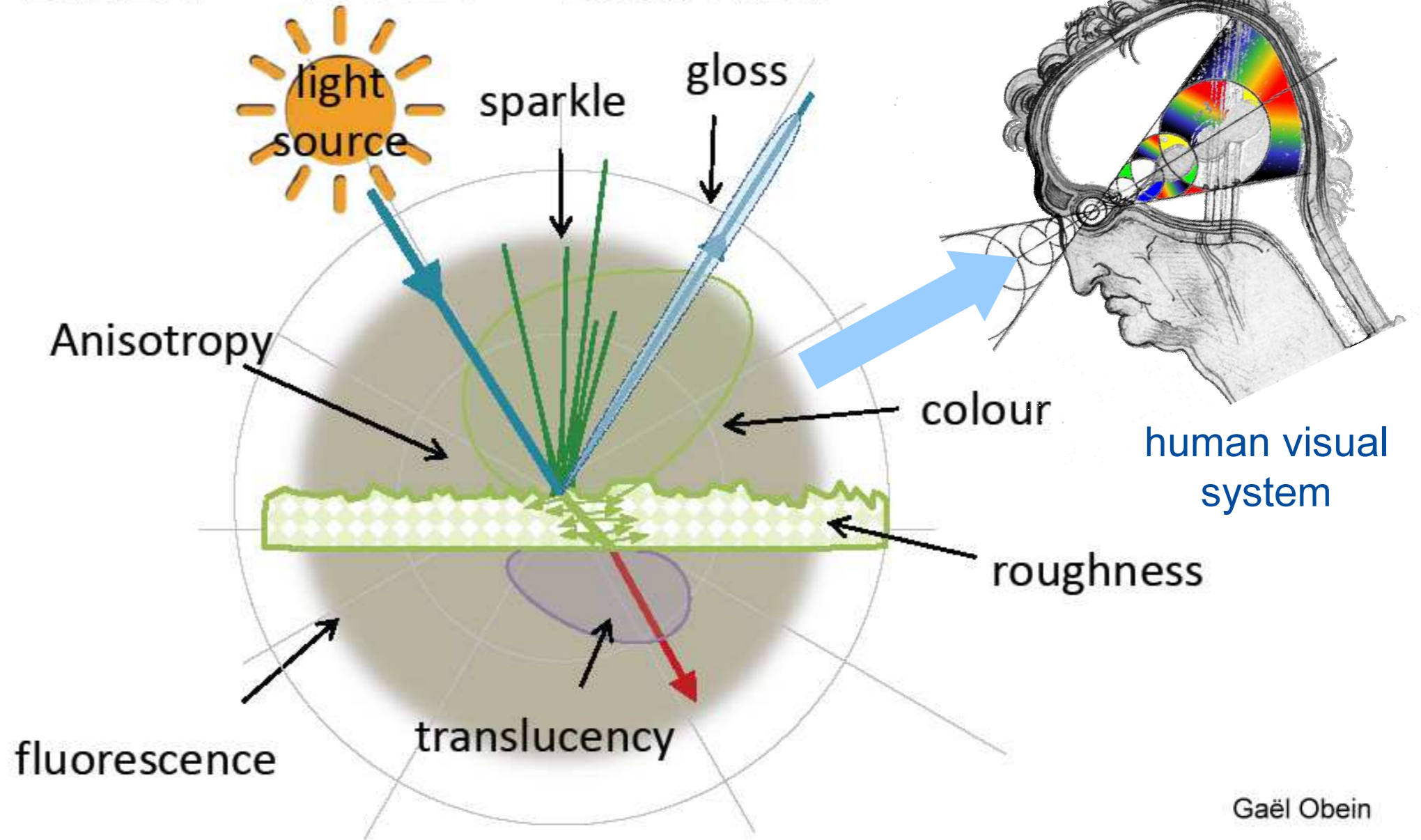

BSSRDF: Bidirectional Scattering Surface Reflectance Distribution Function



Scatter Analysis

Directional Scanning

$$dL_s(\theta_s, \phi_s) = B(\theta_i, \phi_i, \theta_s, \phi_s; \lambda, \vec{p}) dE(\theta_i, \phi_i)$$

The scattering properties of surfaces are generally and completely described by the **bidirectional scatter distribution function (BSDF)** which is a function of the direction of light incidence, the direction of observation, the wavelength of light and its state of polarization.

Assessment and evaluation of the reflective properties of surfaces can be realized by

- **mechanical (motorized) scanning of a range of observation directions** with photometric or spectro-radiometric receivers for one direction of light incidence. This can be done with complex, and bulky high-precision mechanisms (gonio-photometer or gonio-spectroradiometer).

Scanning of the directions of observation **without moving parts**:

- **optical scanning (conoscopy),**
- analysis of the spreading of a point- or line-source of illumination (**PSF - LSF approach**),
- hemispherical projection and imaging ("**imaging hemisphere**").

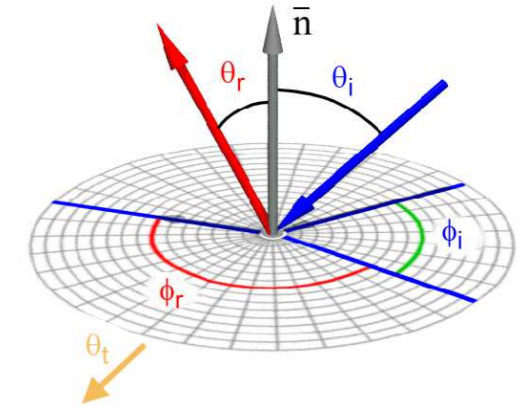

Spectral Reflectance Factor of Objects

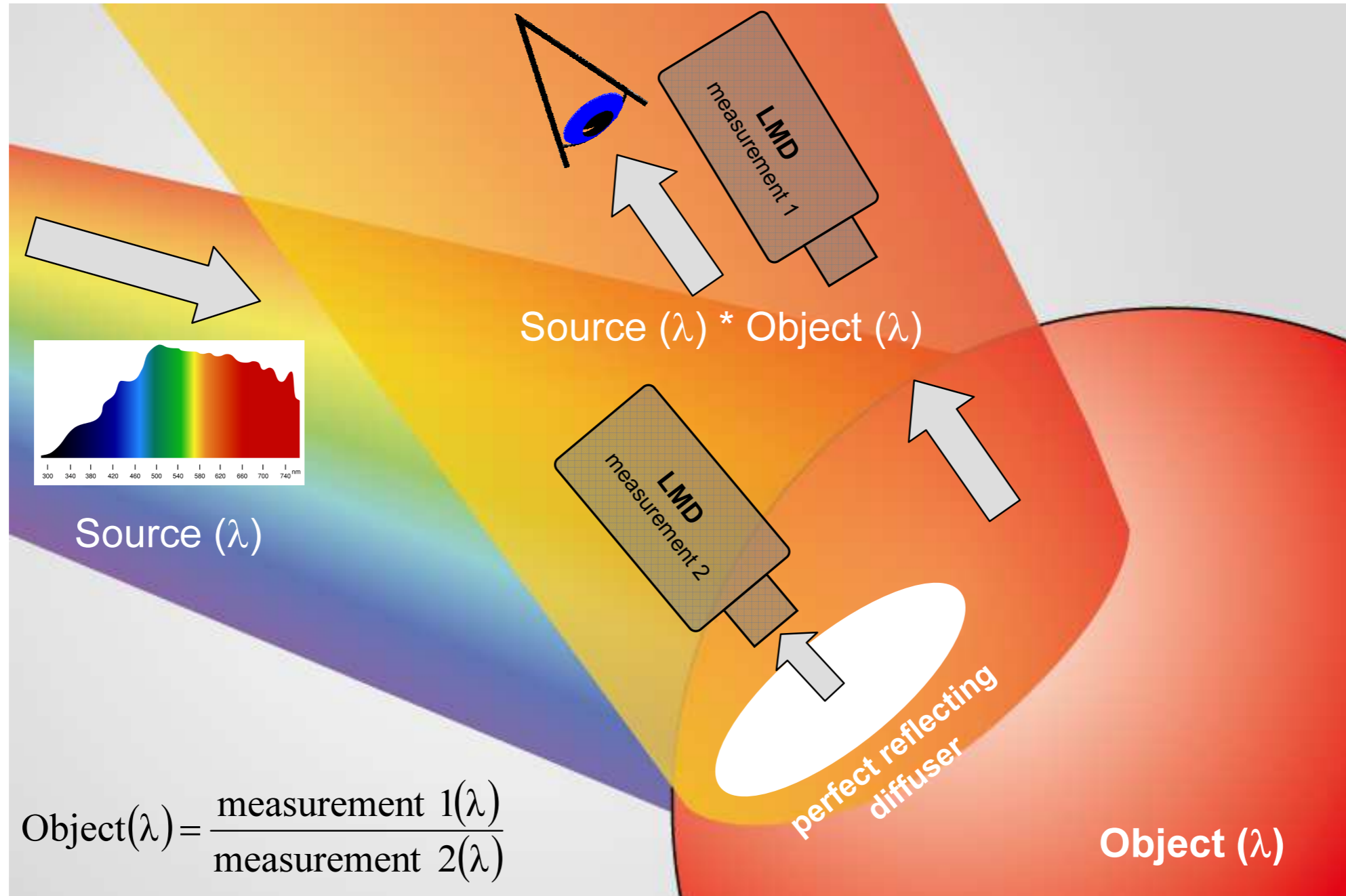

object color - surface color - Körperfarbe



Items to be specified

- geometrical details of illumination:
 - in-plane and directional distribution;
- spectral power distribution;
- temporal aspects (stability, modulation, etc.).

LMD specification (geometry):

- direction of observation / measurement;
- aperture;
- measurement field angle;
- ...

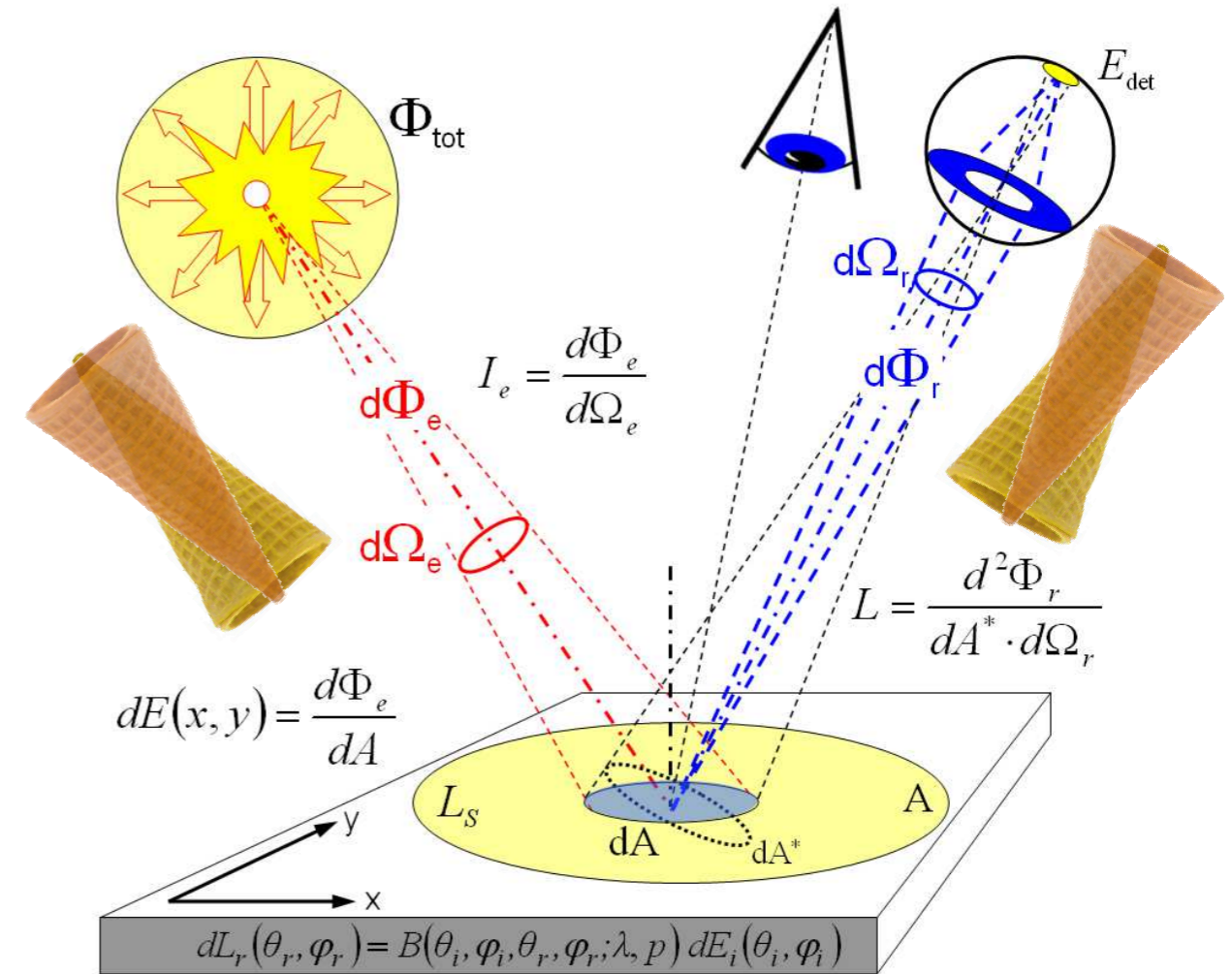

There is an intricate entanglement of illumination, object and LMD.

Reproducibility requires specification of all details.



Displays: Classification

Display

Presentation of haptic or visual information.



Electro-optical Display

Visual presentation of electrically supplied information:
Alphanumeric characters, signs, symbols, etc., static information.

Display Screen

Matrix of picture elements with random selection for display of arbitrary image content, moving images.



Electro-Optical Displays: Emissive vs. Reflective

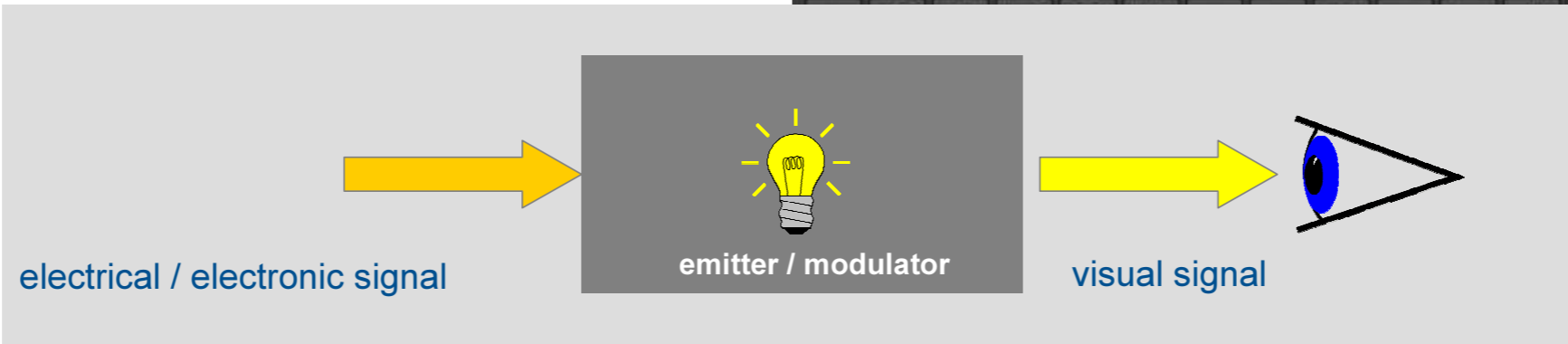
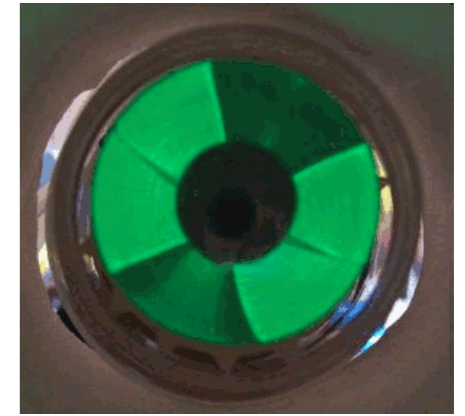

Intended vs. disturbing Reflections

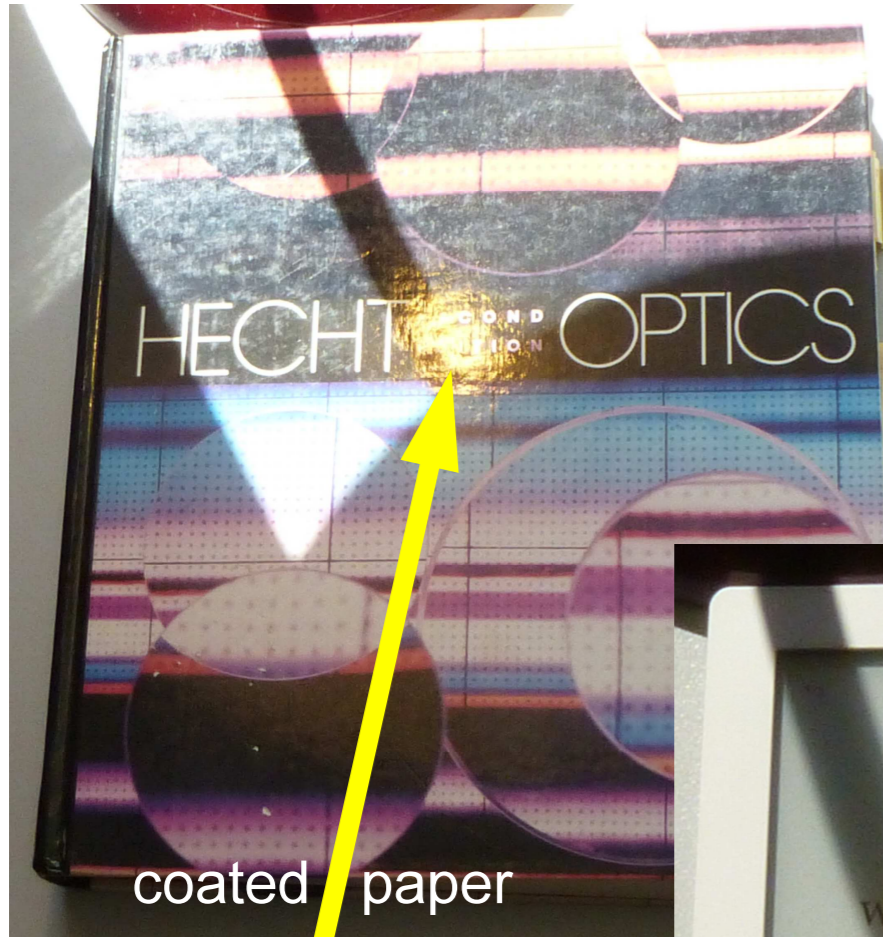

directional
off-specular
illumination
by sun;

high illuminance.

coated paper

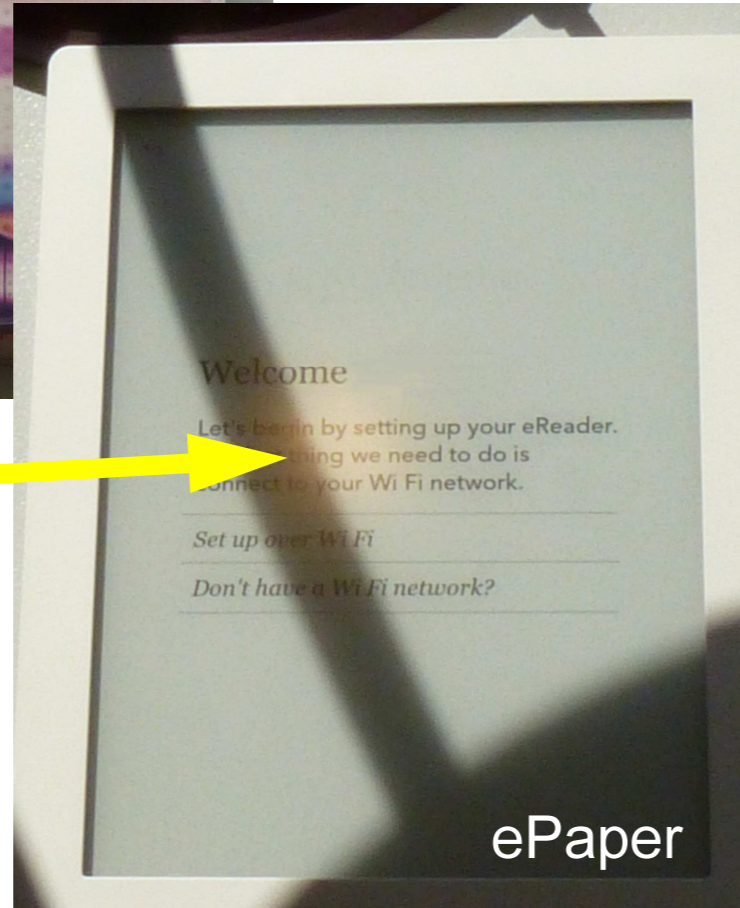

incandescent lamp
in specular direction
→ glare - gloss

ePaper

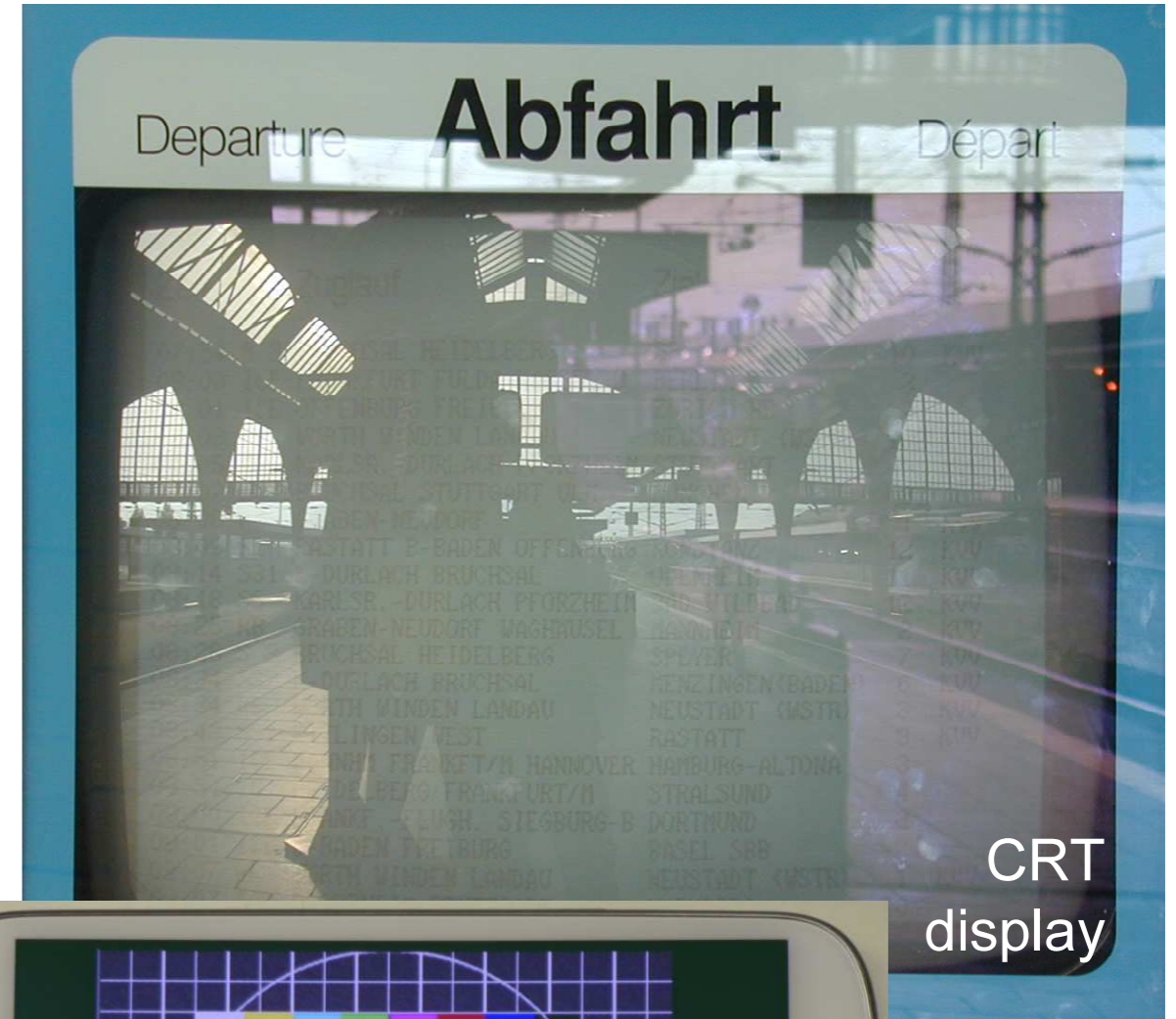

CRT
display

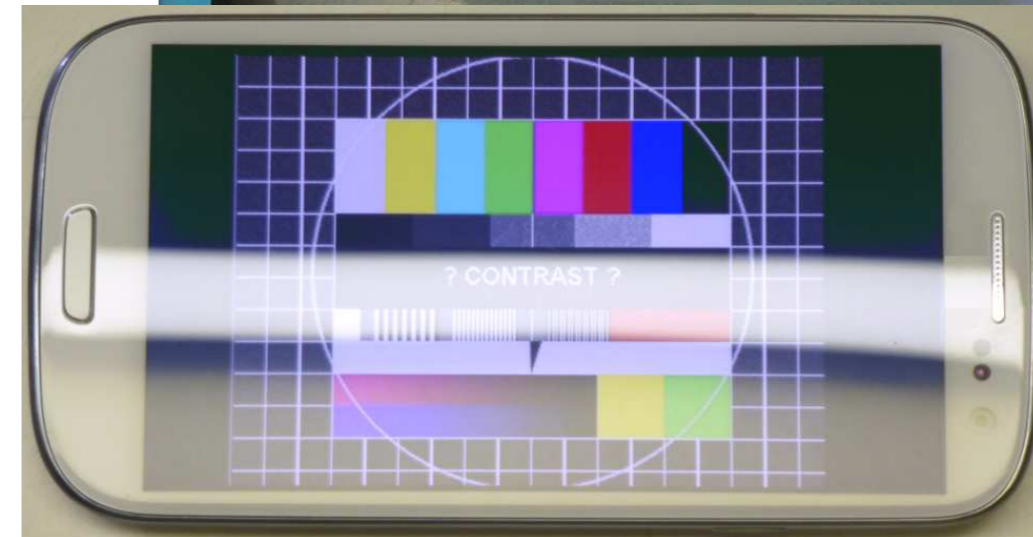

OLED
display



History of the Integrating Sphere

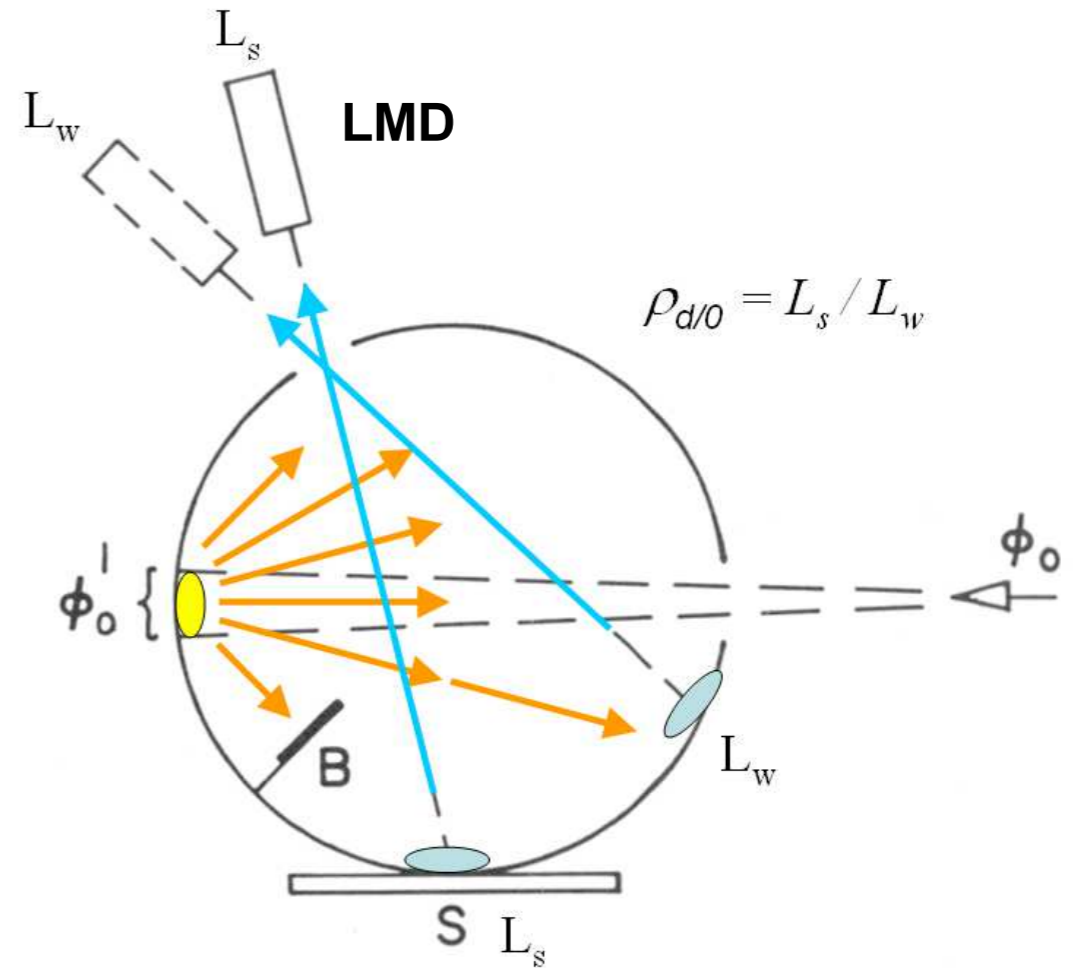
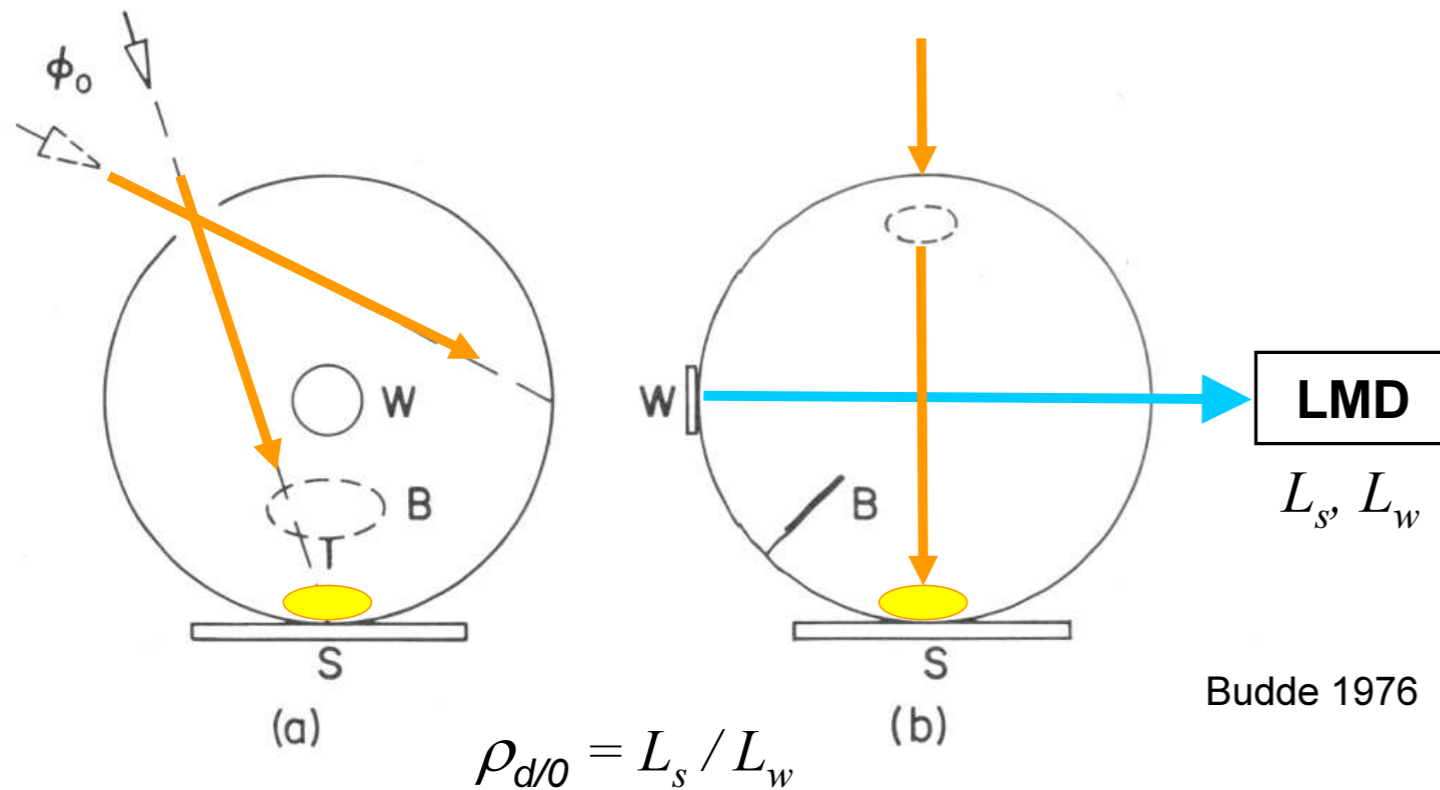

R. Ulbricht: "Das Kugelphotometer: Darstellung seiner Theorie, Ausbildung und Anwendung, unter besonderer Berücksichtigung der Fehlerquellen", 1920
 Measurement of total flux

A. H. Taylor: "A simple portable instrument for the absolute measurement of Reflection and Transmission Factors, Sci. Pap. Bur. Stand. 17, 1(1920)5

C. H. Sharp, W. F. Little: "Measurements of reflection factors, Trans. Illum. Eng. Soc. 15, No.9, 802 (1920)

W. Budde: "Calibration of Reflectance Standards", Journal of research of the National Bureau of Standards - A. Physics and Chemistry, Vol. BOA, No. 4, July-August 1976

Photometric cube described by Buckley in 1920.



IEC 62341-6-2:2015

Organic light emitting diode (OLED) displays

Part 6-2: Measuring methods of visual quality and ambient performance

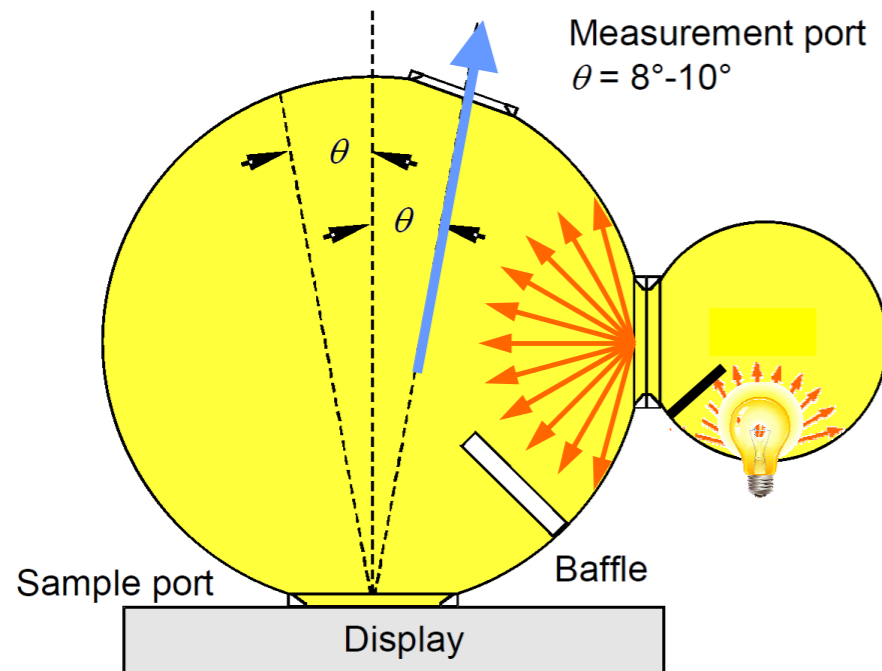

from IEC 62341-6-2

Ambient *indoor room illumination*, and *outdoor illumination of clear sky daylight*, on a display, shall be approximated by the combination of two illumination geometries.

➔ **Uniform hemispherical diffuse illumination** will be used to simulate the background lighting in a room, or the hemispherical skylight incident on a display, with sun occluded.

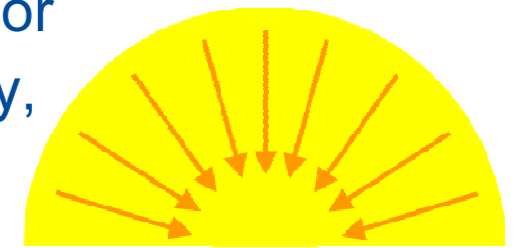

➔ A **directed source in a dark room** will simulate the effect of directional illumination on a display by a luminaire in a room, or from direct sunlight (0.5° subtended angle).



Illumination Conditions

... and Results

Uniform hemispherical diffuse illumination	
Indoors	
Illuminants: Light source closely approximating CIE Standard Illuminant A, CIE Standard Illuminant D65, or fluorescent lamp FL1.	
Results	Illuminance levels
Indoor contrast and color for a typical TV viewing room.	60 lx of hemispherical diffuse illumination, specular included.
Indoor contrast and color for typical office environment.	300 lx
Outdoors	
Illuminants: Light source closely approximating skylight with the spectral distribution of CIE Illuminant D75.	
Results	Illuminance levels
Daylight contrast and color	15 000 lx of hemispherical diffuse illumination, specular included.

Directional illumination	
Indoors	
Illuminants: CIE Standard Illuminant A, CIE Standard Illuminant D65, or fluorescent lamp FL1	
Results	Illumin. levels / geometry
Indoor contrast and color for a typical TV viewing room.	40 lx angular subtense $<8^\circ$
Indoor contrast or color for typical office environment.	200 lx with display in vertical orientation, angular subtense $<8^\circ$
Outdoors	
Light source approximating CIE daylight Illuminant D50; angular subtense $\sim 0.5^\circ$, @ inclination θ_s in vertical plane. LMD normal to display surface area.	
Results	Illumin. levels / geometry
Daylight contrast and color	65 000 lx at an inclination angle of $\theta_s = 45^\circ$ to display normal.



Uniform Hemispherical Diffuse Illumination



Instrument Systems ISP 9000
190 cm inner diameter

More compact solution:
DUT outside the sphere,
"Sampling Sphere"

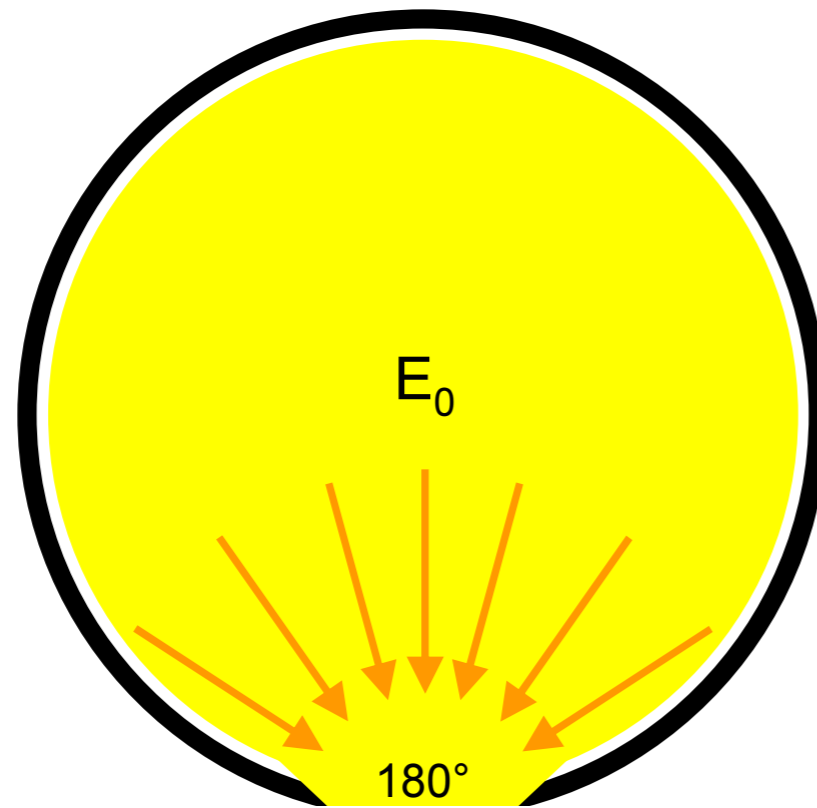

DUT

DUT

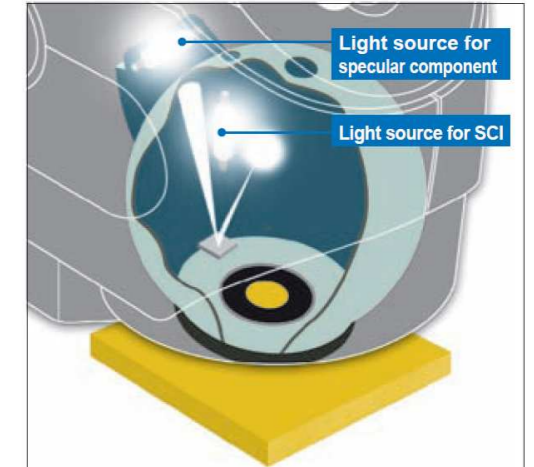
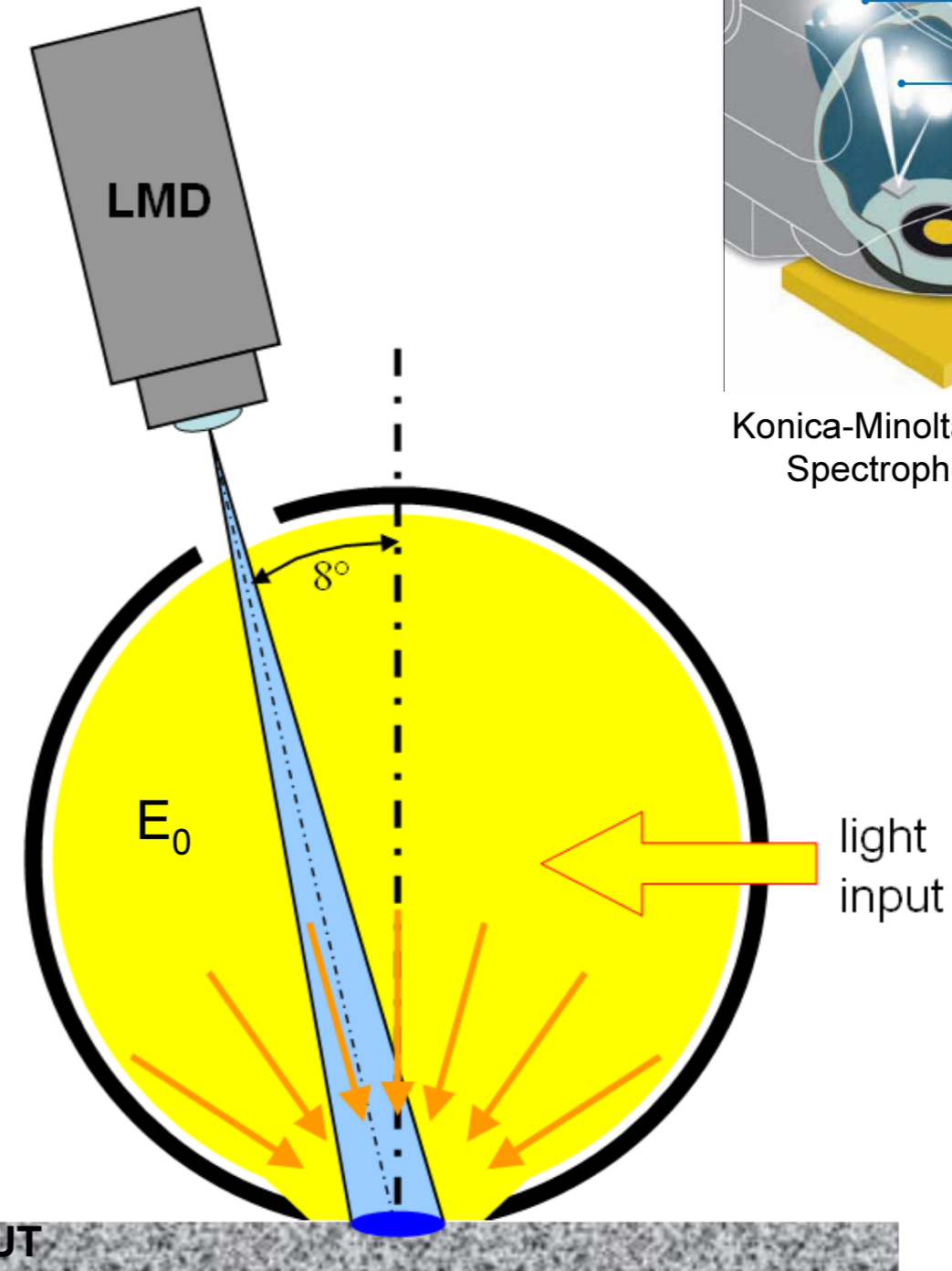

Konica-Minolta CM-2500d
Spectrophotometer



Uniform Hemispherical Diffuse Illumination

SDR: Measurement and evaluation of **spectral diffuse reflectance**

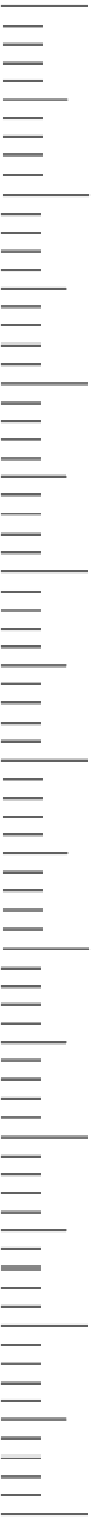
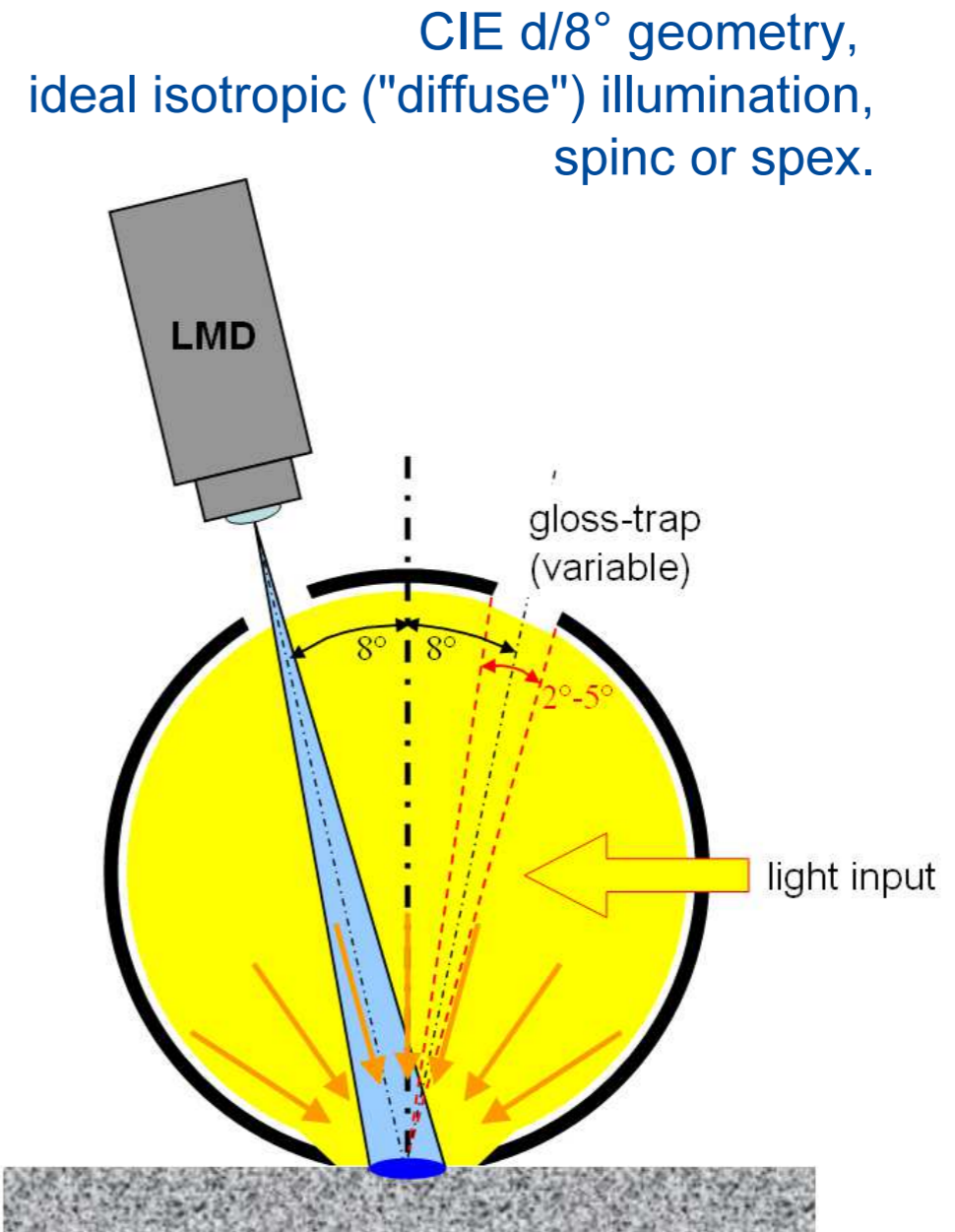
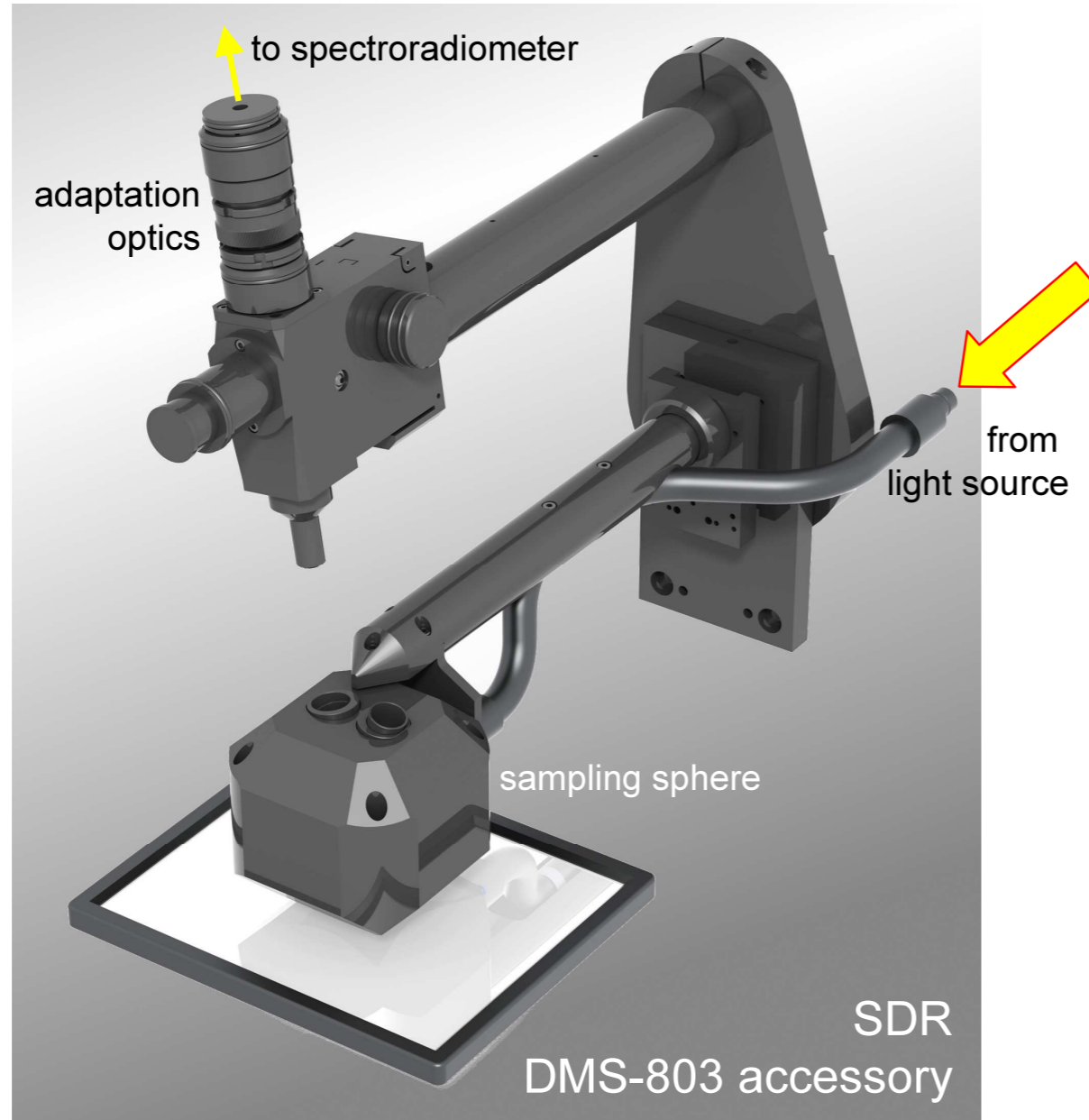

Spectral Reflectance Factor

Ratio of reflected DUT radiant flux ... to that reflected in the same directions by a **perfect reflecting diffuser** identically irradiated or illuminated (CIE ILV 17-1059).

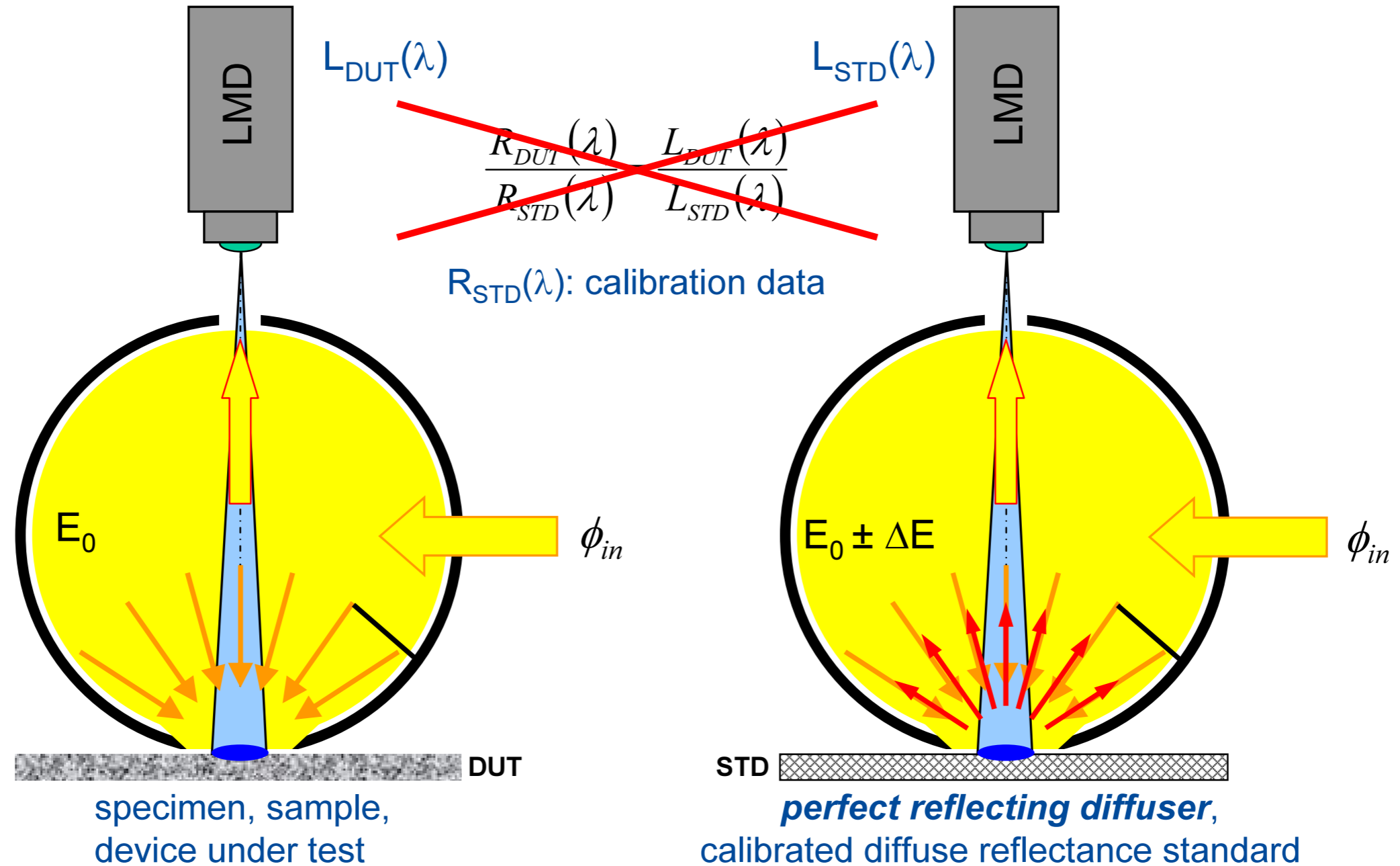

Reflectance Factor

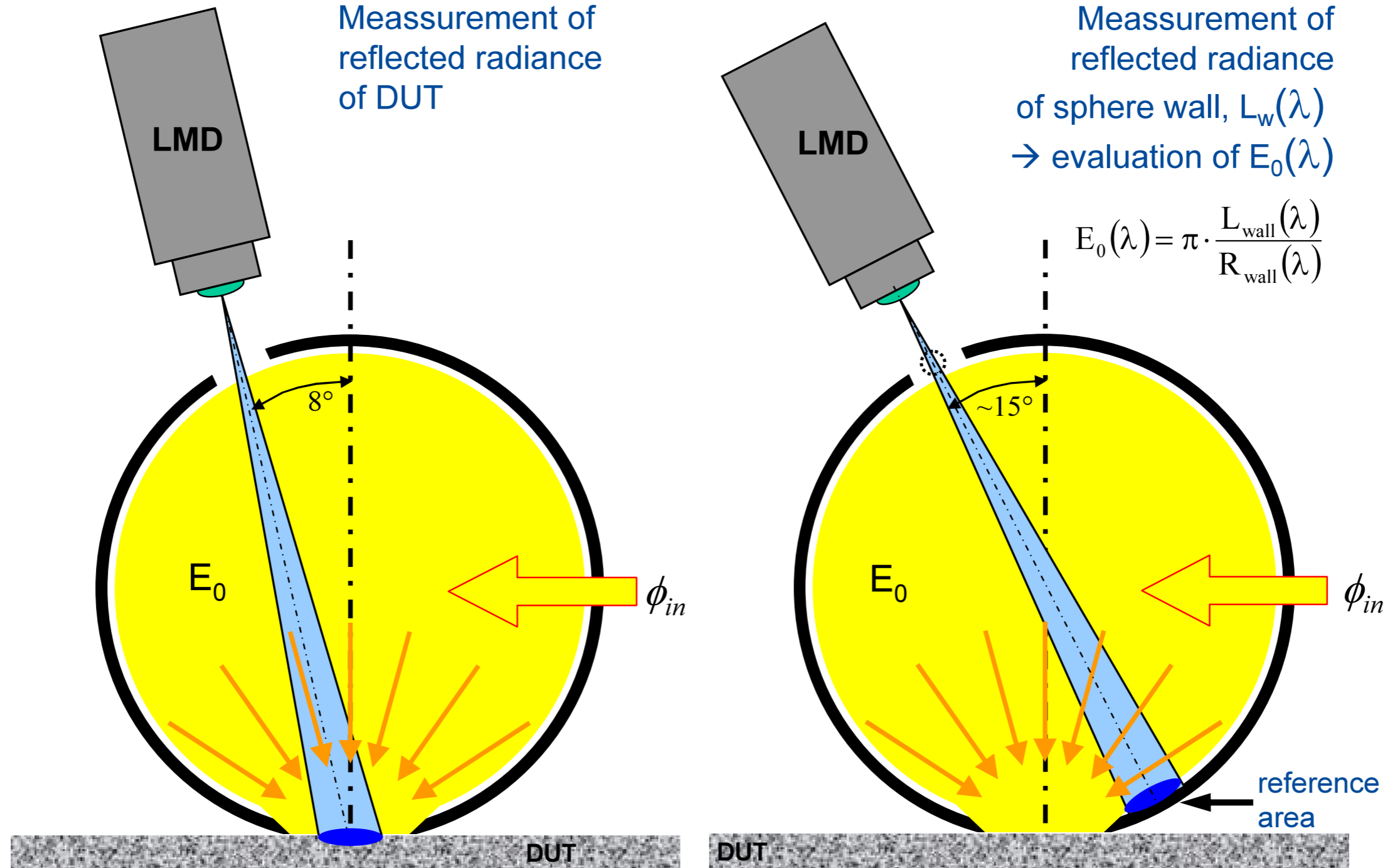

Emission and Sampling Sphere

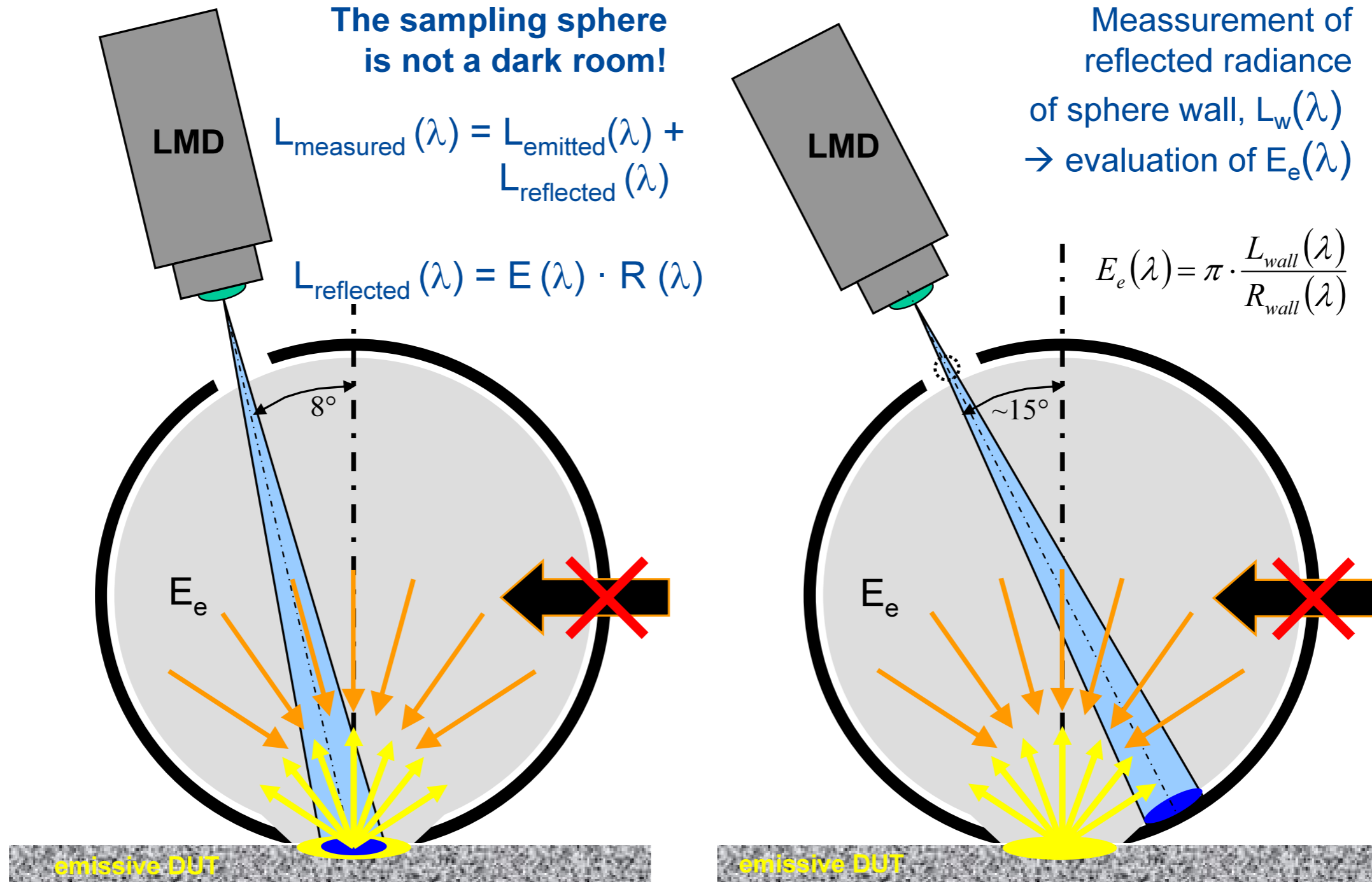

	Sphere calibration	Non-emissive	Non-emissive 2 states	Emissive 2 states
DUT example	---	Object surface	Reflective LCD, other reflective displays (e.g. ePaper)	LCD modules with BLU, OLED displays
Results	spectral correction factor for evaluation of irradiance	Reflectance, surface chromaticity	Reflectance, contrast	Reflectance, contrast, "ambient contrast"
Comment	required for operation of the SDR.	Reflectance and surface chromaticity of arbitrary objects measured under different hemispherical diffuse illumination conditions (spinc/spex).	Reflectance and contrast of reflective displays measured under different hemispherical diffuse illumination conditions (spinc/spex).	Contrast of transmissive and emissive displays measured under different hemispherical diffuse ambient illumination conditions (spinc/spex).
Measured quantities				
		SDR ON		SDR ON/OFF
M1	$L_{std} @ E_0$	→ L_{DUT}	→ L_H	→ $L_{H, ON}$
M2	$L_{sph} @ E_0$			→ $L_{H, OFF}$
M3		→ L_{ref}	→ $L_{H, ref}$	→ $L_{H, ref, ON}$
M4				→ $L_{H, ref, OFF}$
M5			→ L_L	→ $L_{L, ON}$
M6				→ $L_{L, OFF}$
M7			→ $L_{L, ref}$	→ $L_{L, ref, ON}$
M8				→ $L_{L, ref, OFF}$
Calculated results (from measured quantities)				
R1	$k_{tot} (M1, 2)$	$R(\lambda) (M1,3)$	→ $R_H(\lambda) (M1,3)$	$R_H(\lambda) (M1,2,3,4)$
R2			→ $R_L(\lambda) (M5,7)$	$R_L(\lambda) (M5,6,7,8)$
				select E / E_0
R3			R_H, R_L	R_H, R_L
R4				$CR = CR_A(E=0) (M1-8)$
R5			$CR (M1,3,5,7) = R_H / R_L$	$CR_A(E_0) (M1-8, E_0)$
R6				$CR_A(E) (M1-8, E)$
R7				$L(\lambda) = L_{emi}(\lambda) + L_{refl}(\lambda) \rightarrow x, y (u', v') \rightarrow$

8 measurements
4 DUT mmnts
4 ref. mmnts

user selected spectrum & illuminance

further evaluation



Spectral Diffuse Reflectance Factor

OLED display: $R_W = R_K$

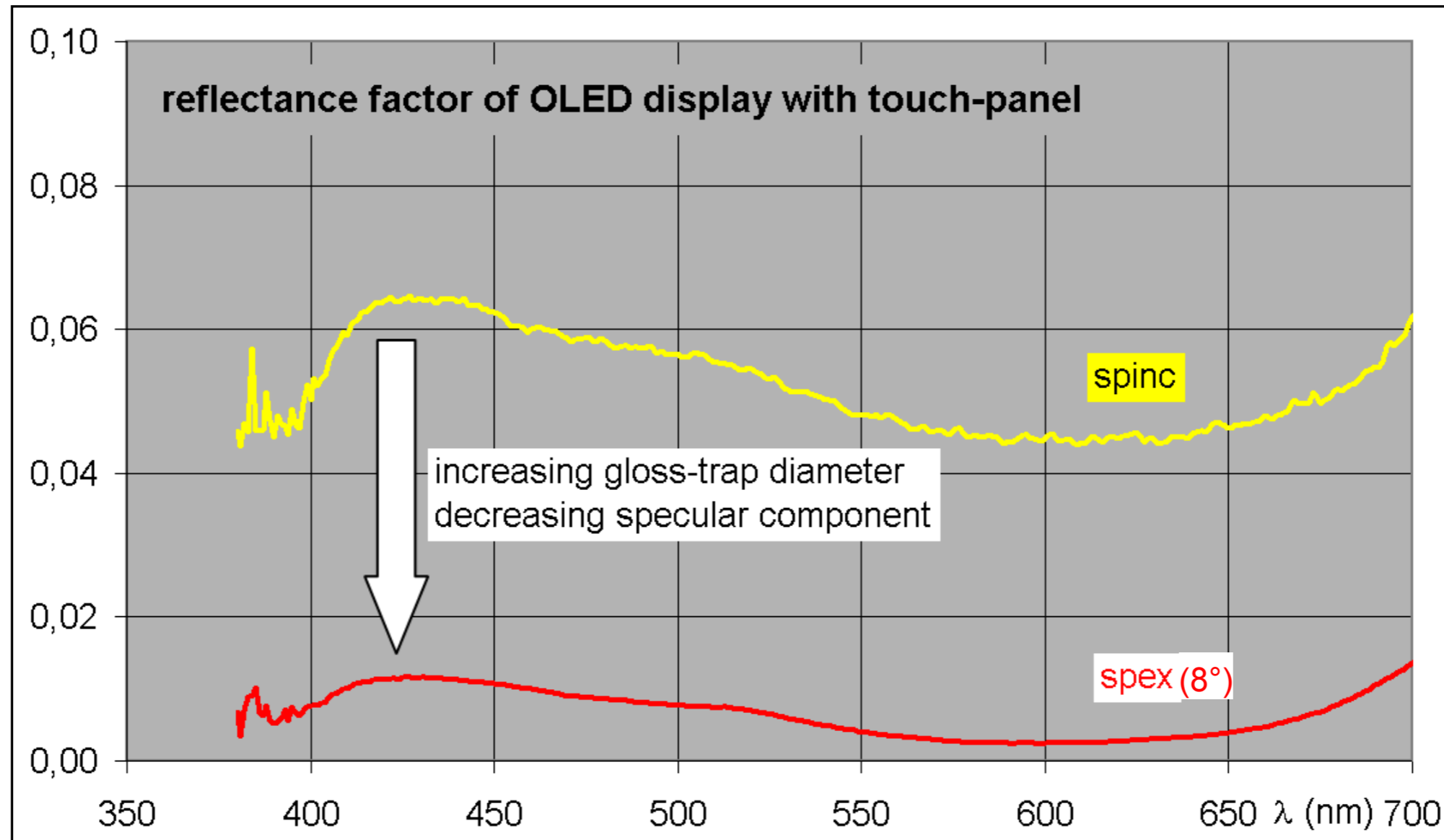

Reflectance factor, $R_{W,K|spinc} = \text{mean} \{R(\lambda) [380-700\text{nm}]\} = 0,0523$

Reflectance factor, $R_{W,K|spex} = \text{mean} \{R(\lambda) [380-700\text{nm}]\} = 0,0066$

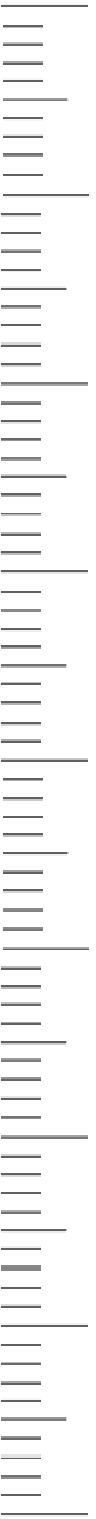

Contrast under Diffuse Ambient Illumination

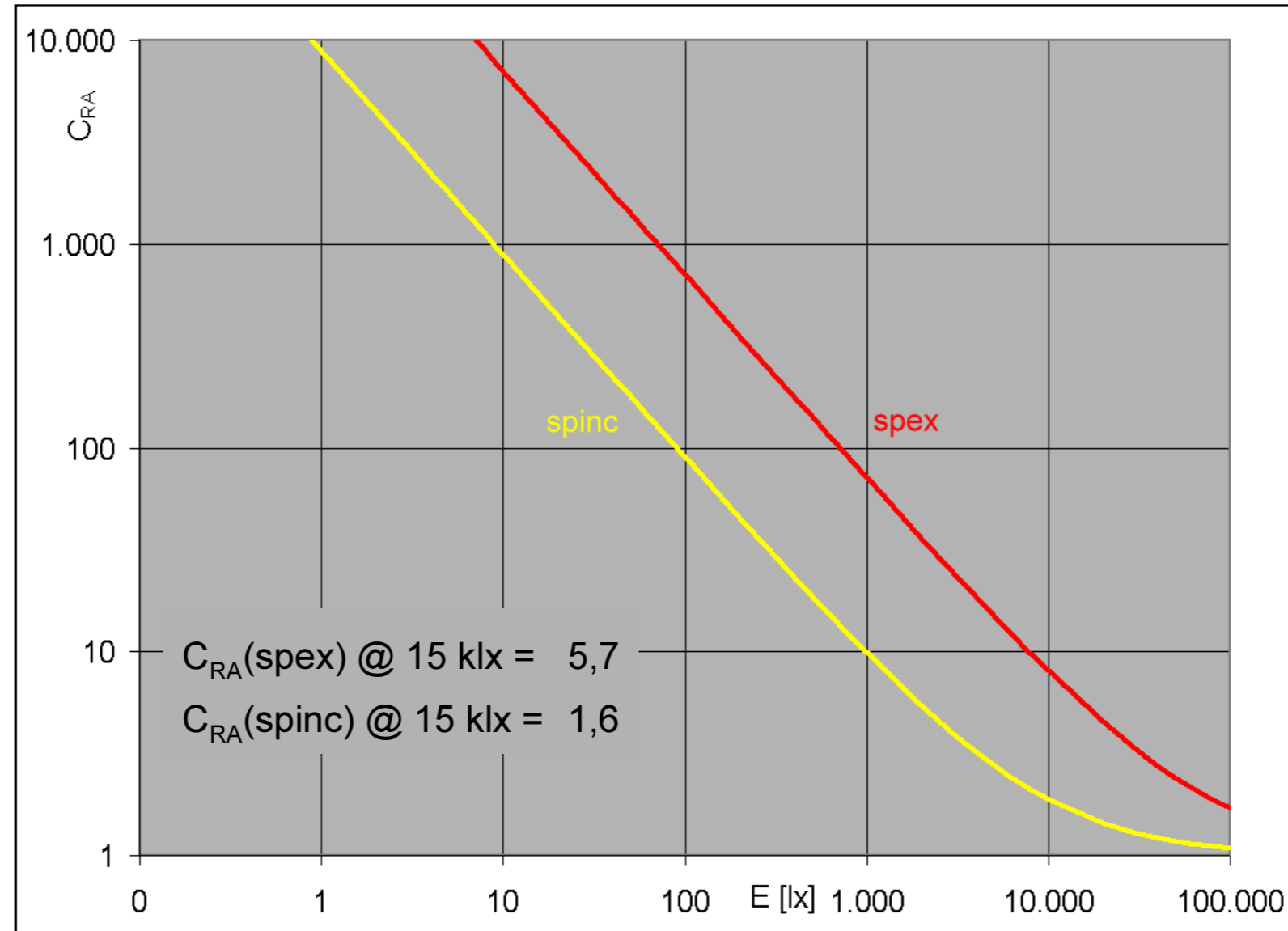

$$C_{RA}(E) = \frac{L_{W,\text{dark}} + R_W \left(\frac{E}{\pi} - L_{\text{ref},W,\text{dark}} \right)}{L_{K,\text{dark}} + R_K \left(\frac{E}{\pi} - L_{\text{ref},K,\text{dark}} \right)} = \frac{L_{W,\text{emi}} + R_{W/K} \cdot \frac{E}{\pi}}{R_{W/K} \cdot \frac{E}{\pi}}$$

with $L_{W,\text{emi}} = 151 \text{ cd/m}^2$
 $L_{K,\text{emi}} = 0,0 \text{ cd/m}^2$



Disturbing Reflections

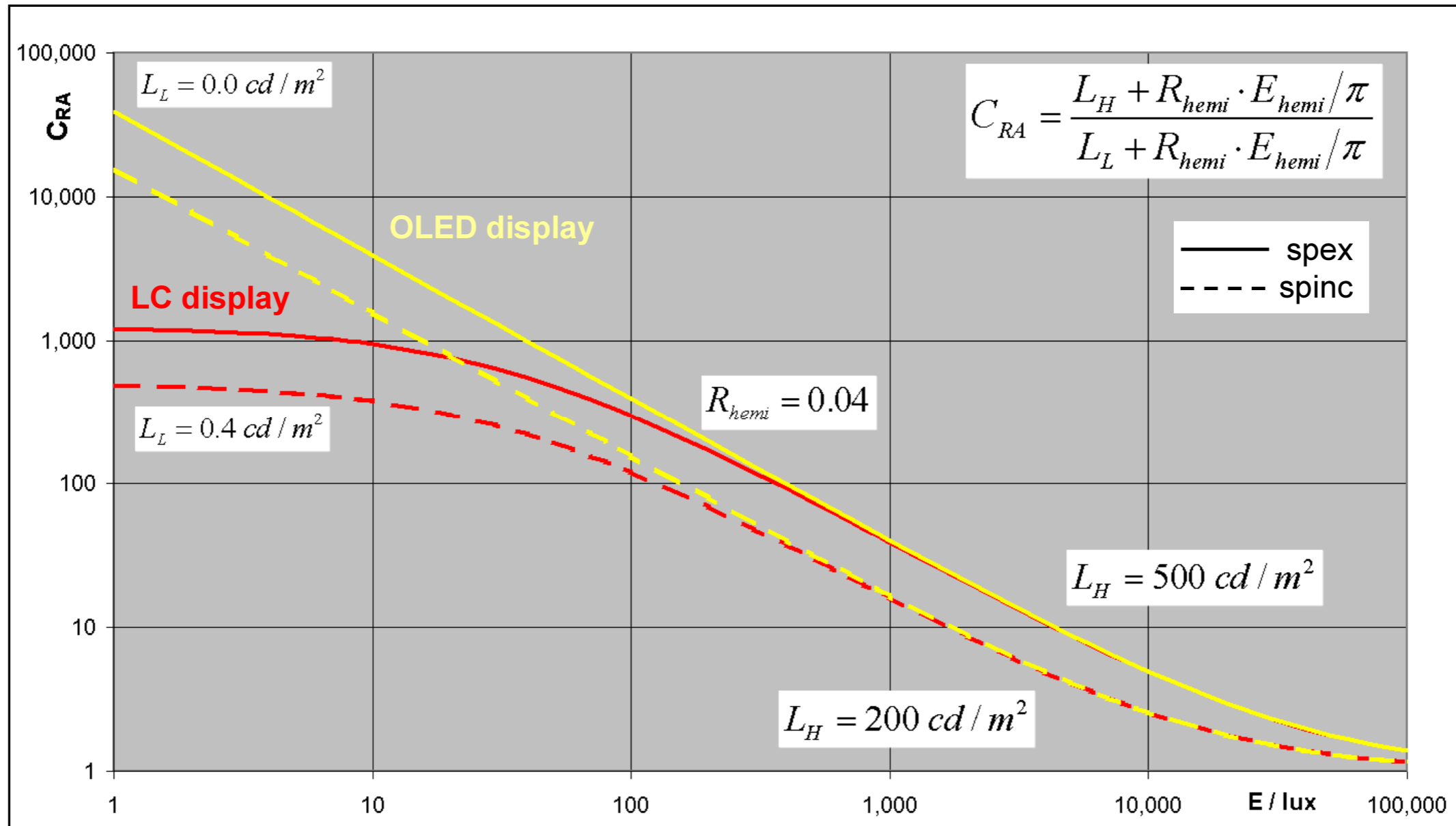

The **low-state luminance**, L_L , determines the contrast in dark surrounds ($E < 100 \text{ lx}$),

the **high-state luminance**, L_H , determines the contrast under high ambient illuminance ($E > 1\,000 \text{ lx}$).



Controlling Unwanted Reflections

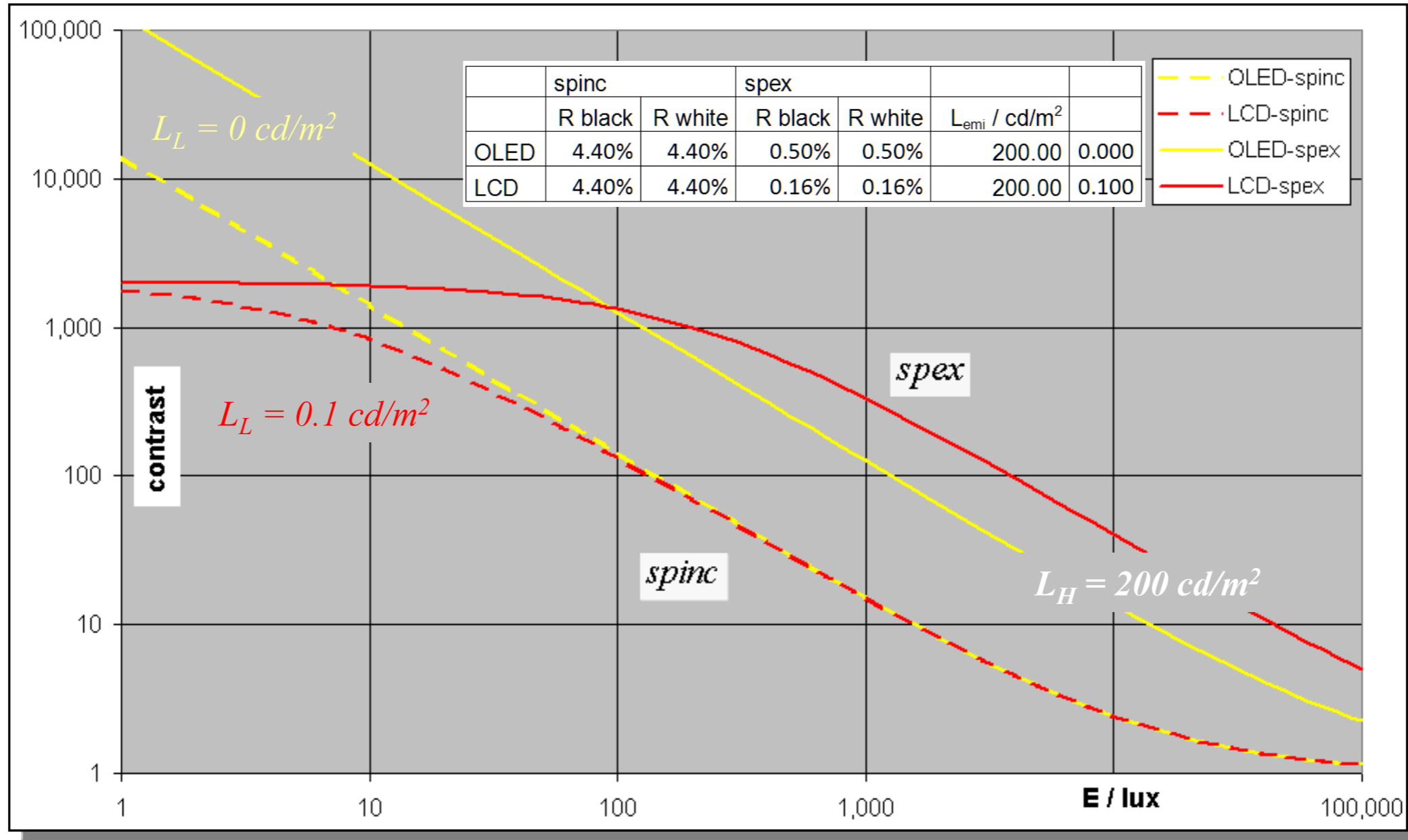

The contrast improvement by **shading the display** with e.g. the head of the observer is obvious.

Display reflectance should be as low as possible for good performance under high illuminance.



Spectral Directional Reflectance Factor

Spectral reflectance factor under directional illumination (@ specified conditions of irradiance, illuminant/spectrum and angle of inclination), evaluated with calibrated diffuse reflectance standard.

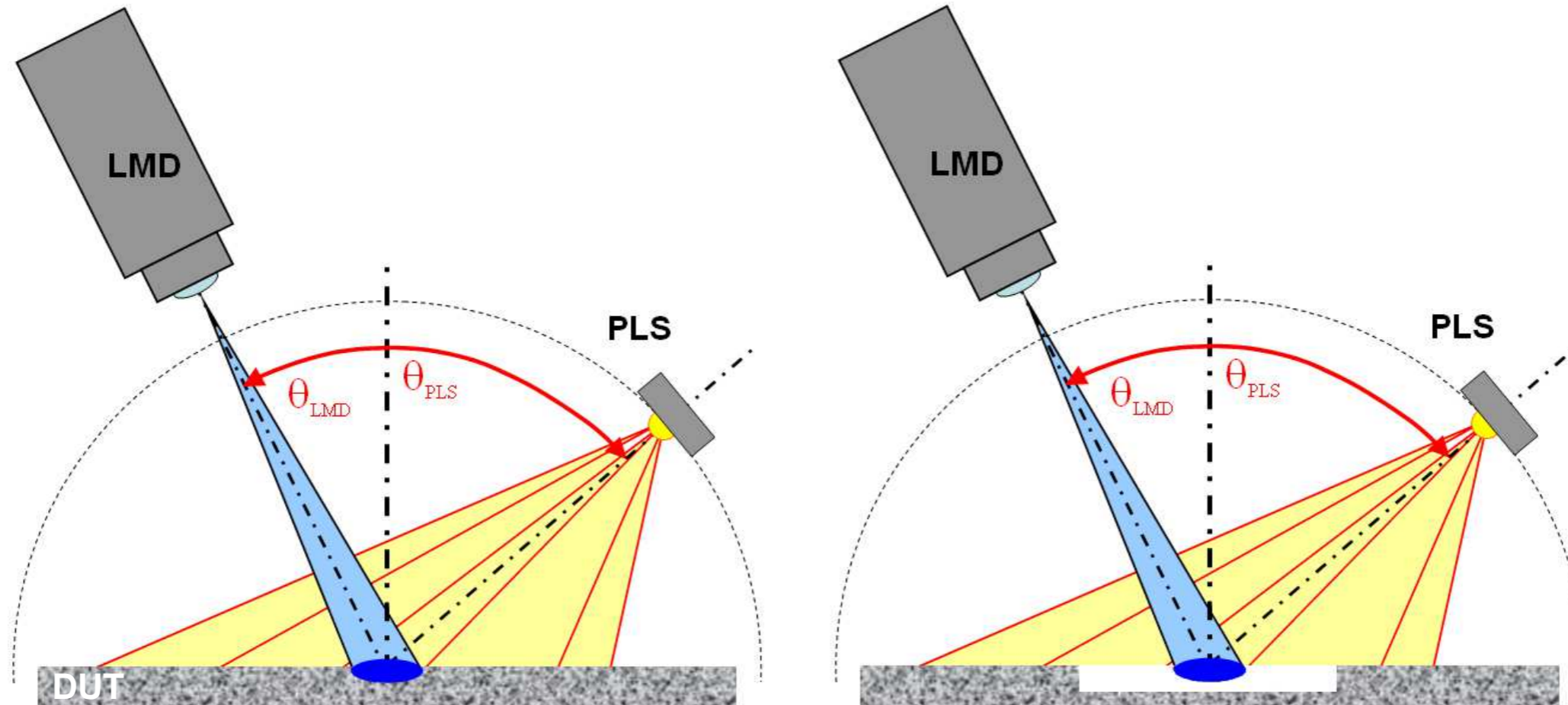

perfect reflecting diffuser,
calibrated diffuse reflectance standard



Reflectance Distribution Function

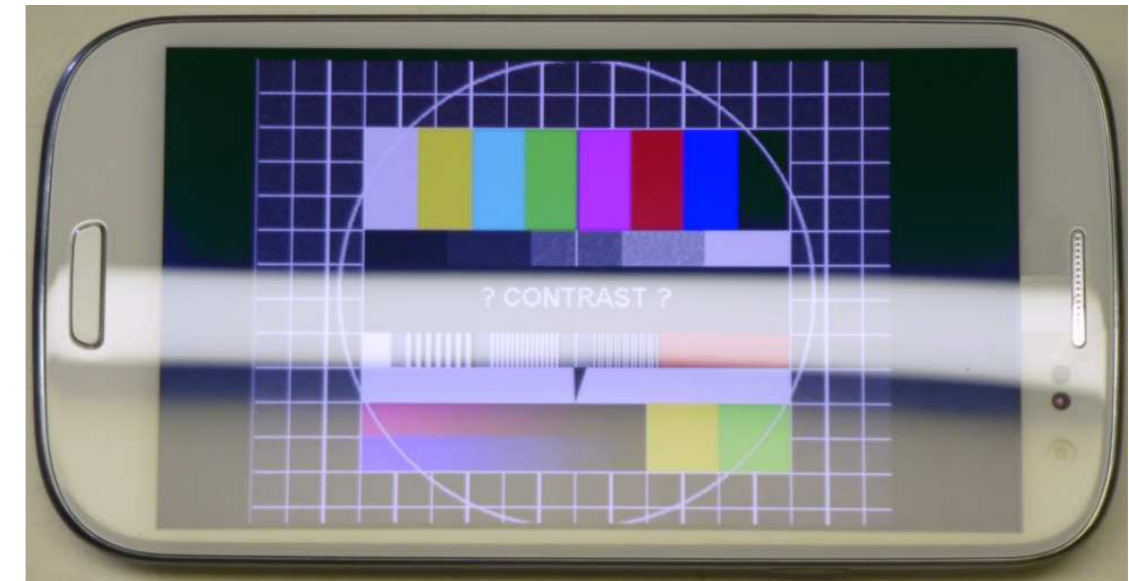
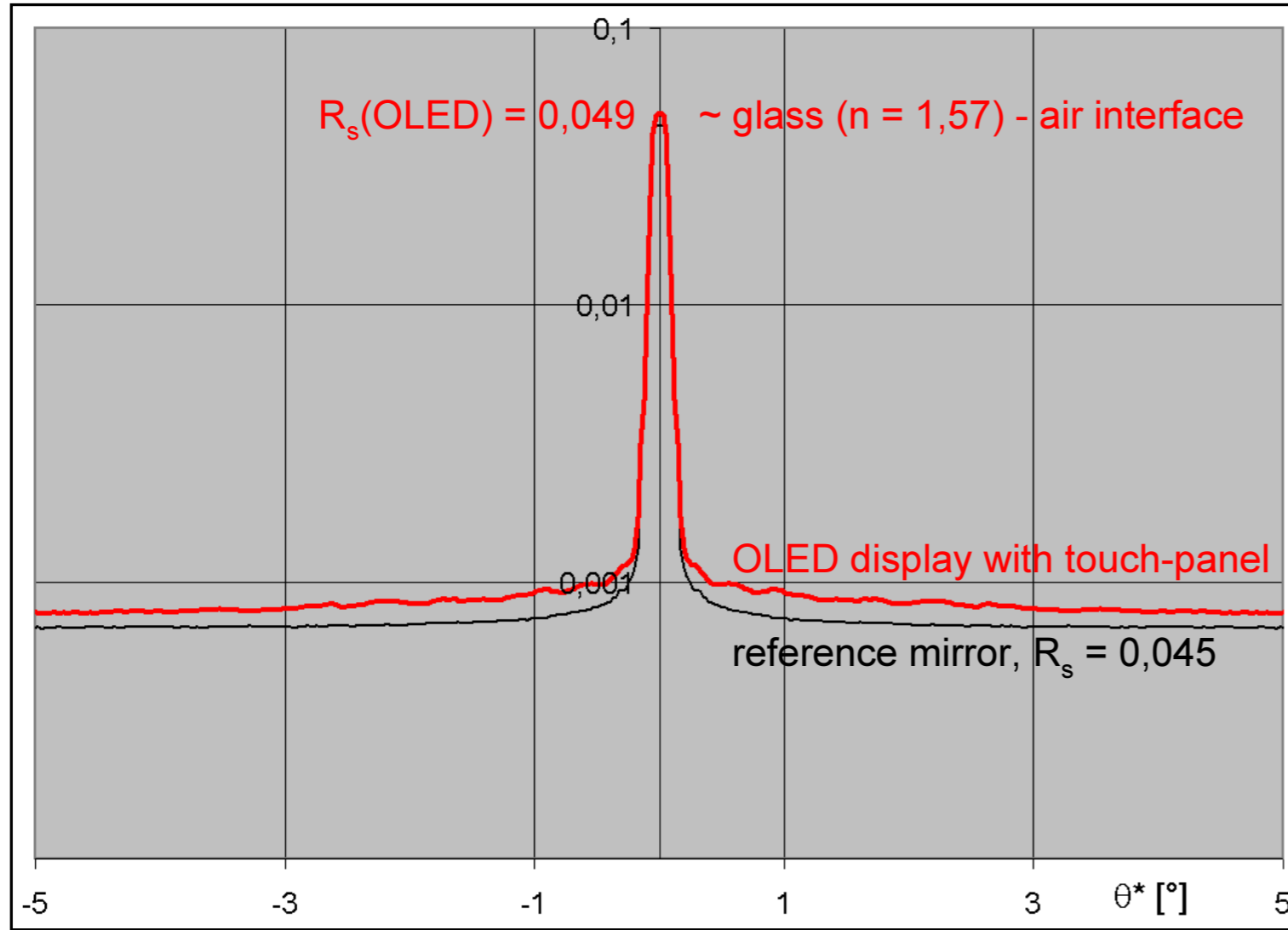

image of linear light source distinctly visible

$$\theta_{\text{PLS}} = 15^\circ$$

$$\theta_{\text{LMD}} = 10^\circ - 20^\circ$$

$$\theta^* = \theta_{\text{LMD}} - \theta_{\text{PLS}}$$

The display surface is a specular (mirror-like) reflector.



Reflectance Distribution Function

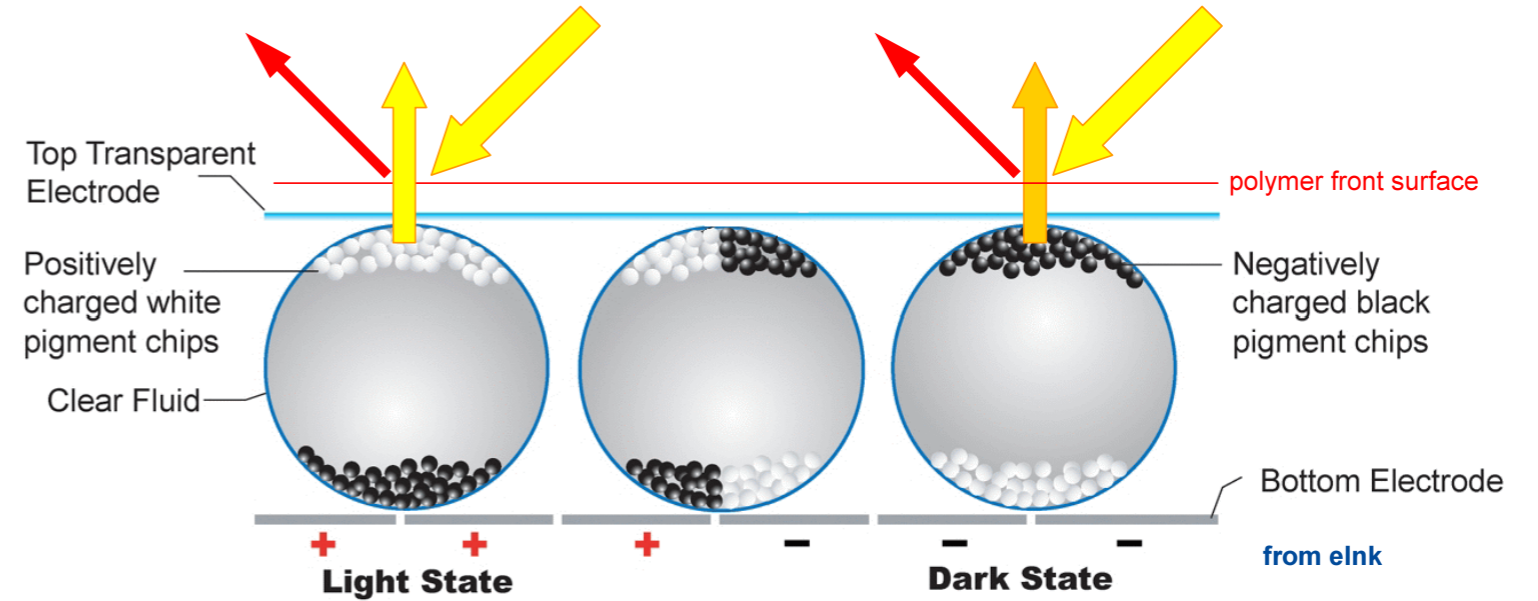
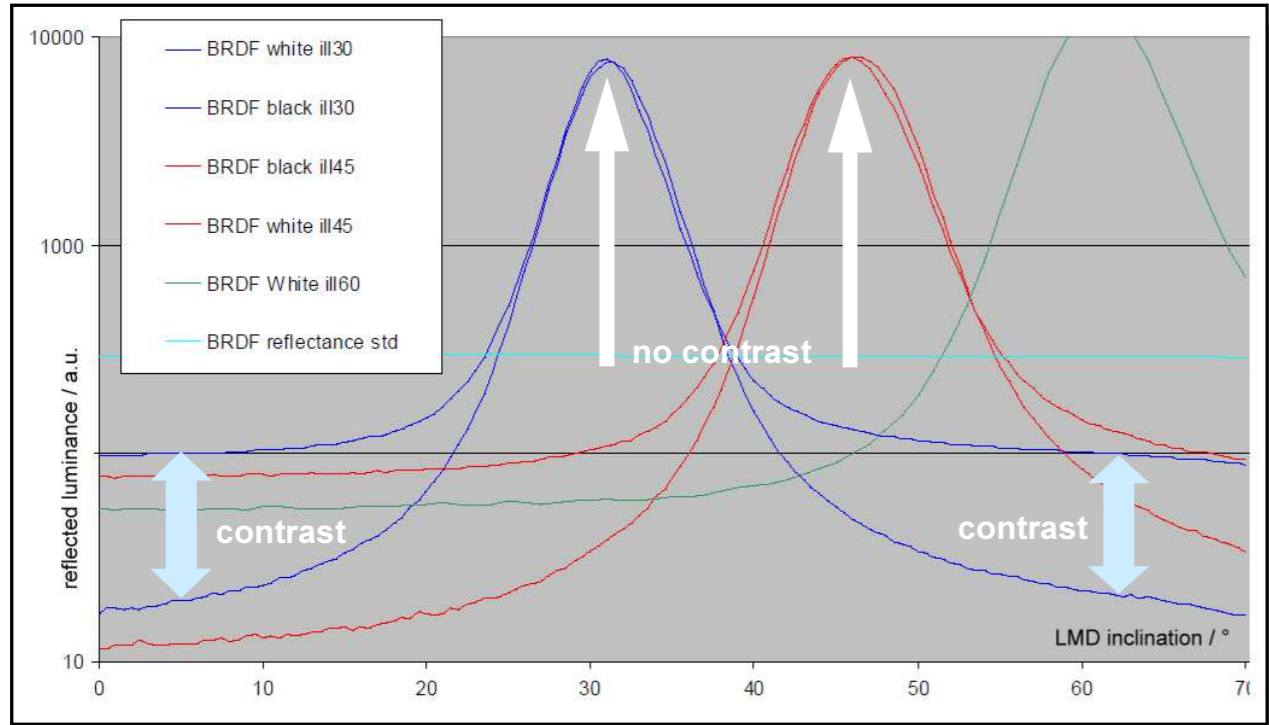

The characteristics of electrophoretic displays are similar to those of coated paper.

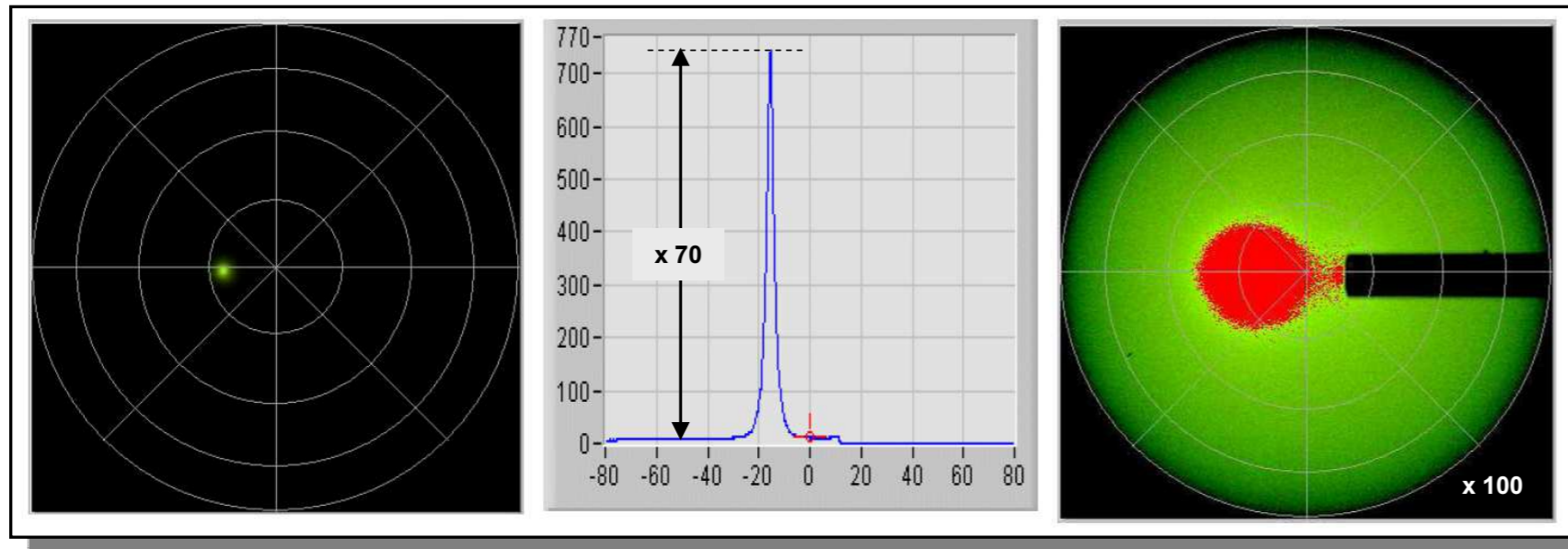

Reflective electro-phoretic displays provide visual information via modulation of light that is scattered into a wide range of directions (quasi-Lambertian).

The contrast in the specular direction is dominated by - unmodulated - surface reflections (~ 4% - 5%) and thus very small.

The unwanted reflections from front surface must be controlled (AG, AR coatings) to rescue contrast.



Conclusions

- ◆ The contrast under ambient illumination is significantly affected by the amount and the directional distribution of reflected light.
- ◆ Reproducible indoor and outdoor illumination conditions are specified by e.g. IEC 62341-6-2.
- ◆ After evaluation of the spectral reflectance factors all illuminance levels and illuminants can be applied to obtain the contrast and the chromaticities by calculation.
- ◆ With the SDR the DMS series of instruments offers the first implementation of the measurement process according to IEC 62341-6-2 under diffuse hemispherical illumination. Together with the directional PLS the complete measurement process can be carried out.
- ◆ Acquisition of the individual measurement steps is supported together with bookkeeping and evaluation by specific software.



Thank you for your attention !

